



SOLID WOOD DOORS





Koetter Woodworking is proud to be the Midwest's leading manufacturer of quality architectural wood products.

For over half a century, we have provided products and solutions for the residential and commercial building industry as well as fine furniture and cabinet manufacturers.

In addition to the products we manufacture, we proudly partner with a variety of supply chains, allowing us to be your one-stop source for mouldings, doors, stair components, specialty millwork and more.



KW2000, Poplar w/MDF Panel, D23/403

CHOOSING THE PERFECT DOOR

When building a new home, the end of the project is typically where costs are cut and the doors and millwork, two of the most critical design elements, tend to be the first items considered when sacrifices are made. Koetter Woodworking wants to change that. We believe that choosing solid wood doors should be viewed as an investment – a value added feature that adds instant equity to your home. Koetter Woodworking wants to bring back the time-honored tradition of quality and craftsmanship when it comes to selecting your doors.

Every door Koetter Woodworking manufactures is carefully hand-crafted from some of the finest woods available. Each hand-assembled, furniture quality door features traditional stile and rail construction, providing lasting strength and durability, creating doors to last a lifetime.

Whatever architectural design your project calls for, Koetter Woodworking is sure to offer a door that expresses your personal style, adding that wow-factor to your home or project.



On the following pages you will find an extraordinary selection of over 300 door styles, each categorized into one of nine recognized architectural styles, to help simplify the selection process when choosing your perfect doors.

KB1002, Poplar w/MDF Panel, D13/403 v-groove

In addition to wood doors, Koetter Woodworking supplies a full line of architectural millwork and stair parts.

ARCHITECTURAL MILLWORK



SOLID WOOD DOORS



STAIR PARTS





DOORS

Barn Doors & Barn Door Hardware	39-41
Colonial	4-5
Contemporary	6-7
Craftsman	8-9
French Country	10-11
Mediterranean	12-13
Modern Farmhouse	14-15
Tudor	16-17
Tuscan	18-19
Victorian	20-21
Reference Guide – Panel Doors	22-25
Louver and Dutch Doors	26
1-3/8" Interior Panel & Rail Options	27-28
1-3/4" Interior Panel & Rail Options	29-30
1-3/4" Exterior Panel & Rail Options	31
2-1/4" Interior Panel & Rail Options	32
2-1/4" Exterior Panel & Rail Options	33
Applied Moulding Options	34
Signature Prime™ Doors	36
Fire Rated Doors	37
Reference Guide – Lited Doors	42-46
Transom Sashes	47
Sidelites	48
Interior Glass Options	50-51
Exterior Glass Options	52
Custom Glass Options	54-55
Hardware	56-59
Jams & Accessories	60-61
Wood Species	62

DOOR INFORMATION 63

Photographs shown in this catalog are for reference only. Koetter Woodworking is not responsible for variations in appearance based on door size. Please confirm specifications with your sales representative prior to ordering.





Courtesy - Loyd Builders, Apex NC

COLONIAL

CLASSIC, STATELY DESIGN.

Recommended Door Profile

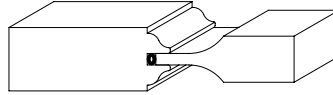

B11-241

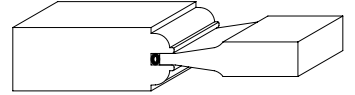

E11-131

PANEL DOORS

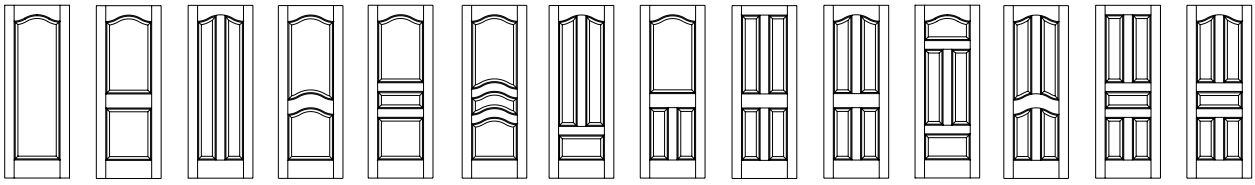

KW1300 KW2300 KW2320 KW2340 KW3300 KW3301 KW3360 KW3390 KW4000 KW4300 KW4304 KW4390 KW5000 KW5300

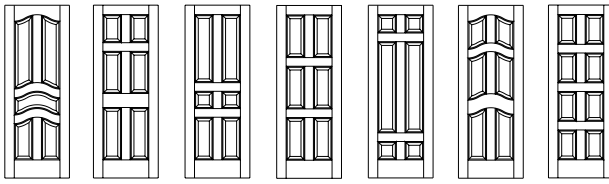

KW5390 KW6000 KW6030 KW6040 KW6060 KW6370 KW8000

LITED DOORS

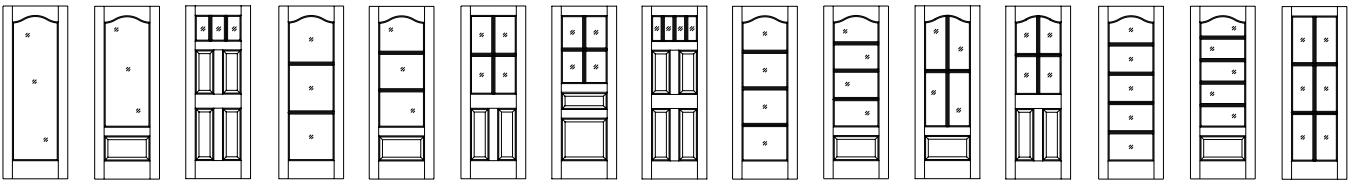

G01300 G01311 G03040 G03300 G03311 G04020 G04021 G04040 G04300 G04311 G04312 G04320 G05300 G05310 G06001

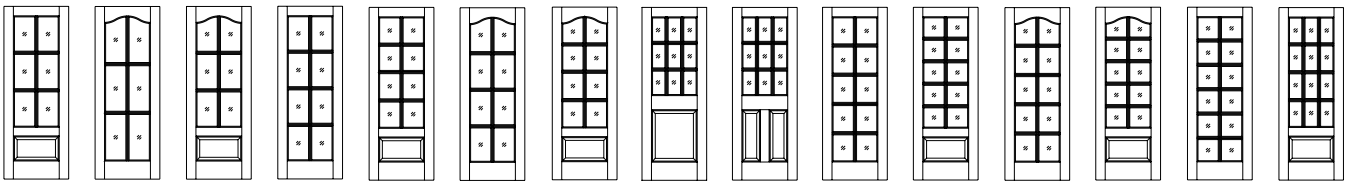

G06011 G06301 G06311 G08000 G08011 G08300 G08311 G09010 G09020 G10000 G10010 G10300 G10310 G12000 G12011

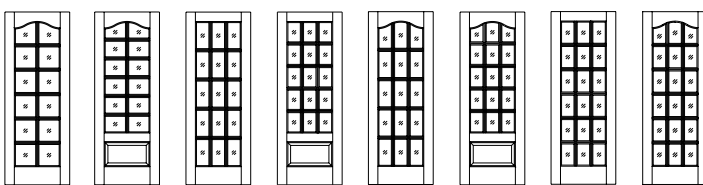

G12300 G12310 G15000 G15010 G15300 G15310 G18000 G18300





Courtesy - MBN Properties, Columbia City, IN

CONTEMPORARY

CLEAN LINES WITH SUBTLE SOPHISTICATION.

Recommended Door Profile

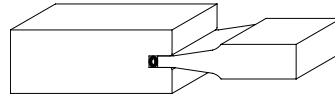

D11-131

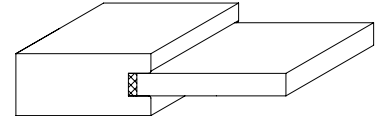

D13-403

PANEL DOORS

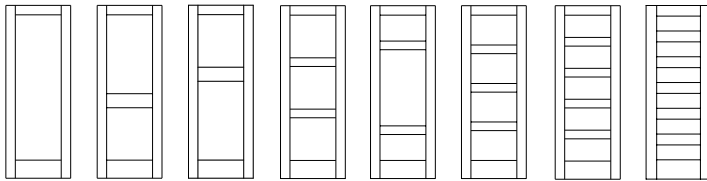

KW1000 KW2000 KW2030 KW3020 KW3080 KW4020 KW5020 KW6050

LITED DOORS

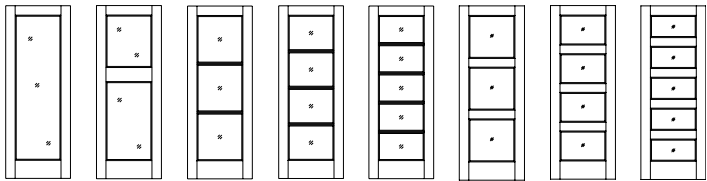

G01000 G02003 G03000 G04000 G05000 G03001 G04003 G05001





CRAFTSMAN

RICH, CHARACTER AND TIMELESS APPEAL.

Recommended Door Profile

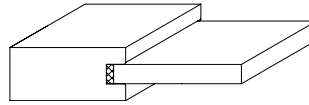

D13-403

PANEL DOORS

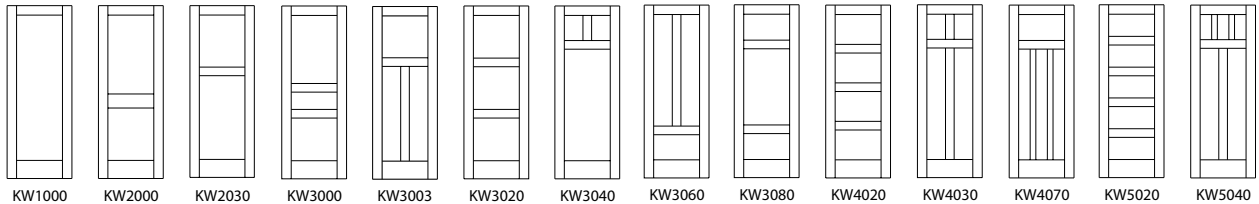

KW1000 KW2000 KW2030 KW3000 KW3003 KW3020 KW3040 KW3060 KW3080 KW4020 KW4030 KW4070 KW5020 KW5040

LITED DOORS

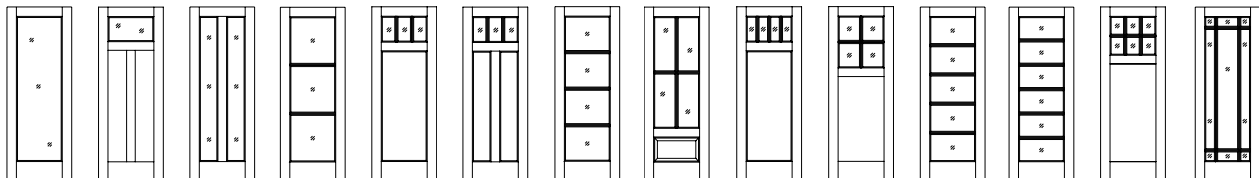

G01000 G01023 G02000 G03000 G03012 G03023 G04000 G04012 G04013 G04014 G05000 G06000 G06012 G09000

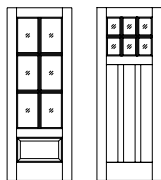

G06011 G06030



G03511CAP, w/ Custom Radius, KW Mahogany,
Opal Glass, A-ADM Applied Moulding/261
Panel, Custom Direct Set Transom



Courtesy - Loyd Builders, Apex, NC

FRENCH COUNTRY

CASUAL ELEGANCE WITH NATURAL INFLUENCES.

Recommended Door Profile

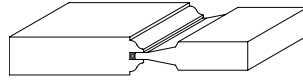

B11-341

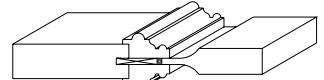

D11-241 with B-ADM applied moulding

PANEL DOORS

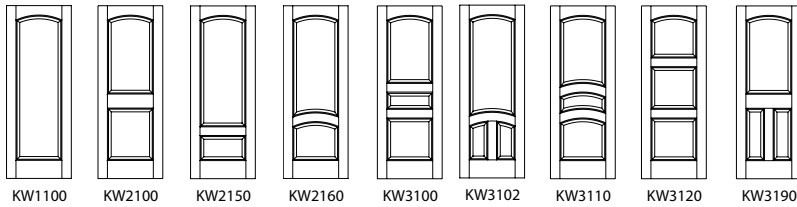

KW1100 KW2100 KW2150 KW2160 KW3100 KW3102 KW3110 KW3120 KW3190

LITED DOORS

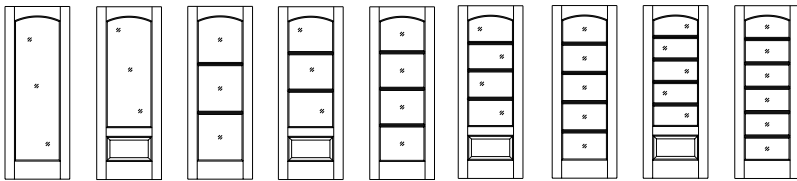

G01100 G01111 G03100 G03111 G04100 G04111 G05100 G05110 G06100

ARCH TOP DOORS

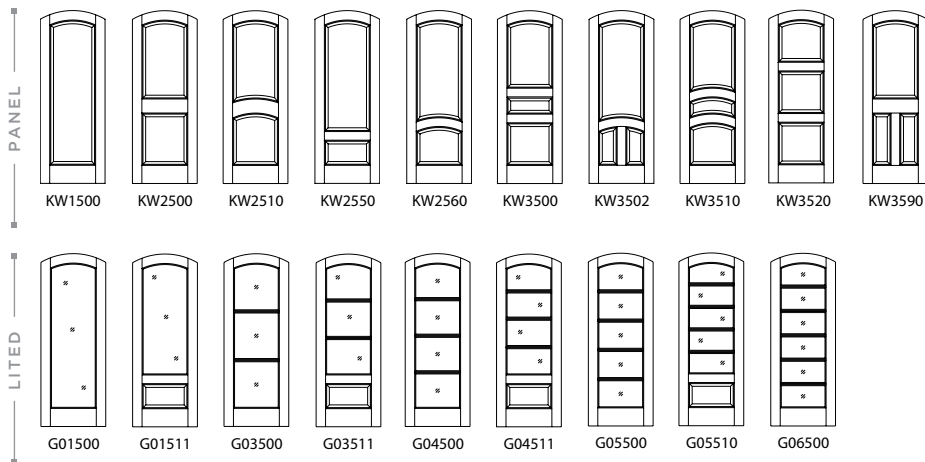

KW1500 KW2500 KW2510 KW2550 KW2560 KW3500 KW3502 KW3510 KW3520 KW3590

G01500 G01511 G03500 G03511 G04500 G04511 G05500 G05510 G06500





Courtesy - Loyd Builders, Apex, NC

MEDITERRANEAN

BOLDNESS WITH SIMPLICITY AND WARMTH.

Recommended Door Profile

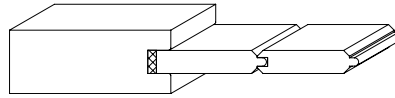

D13 w/ 16-DP-TVG

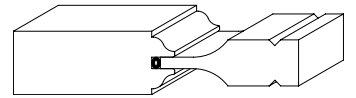

B11 / 241 Vee Groove

PANEL DOORS

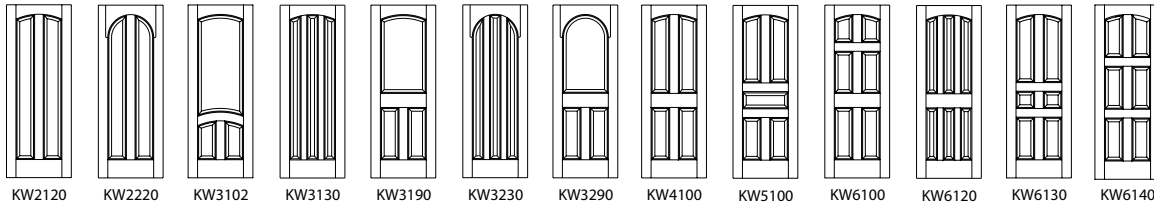

KW2120 KW2220 KW3102 KW3130 KW3190 KW3230 KW3290 KW4100 KW5100 KW6100 KW6120 KW6130 KW6140

LITED DOORS

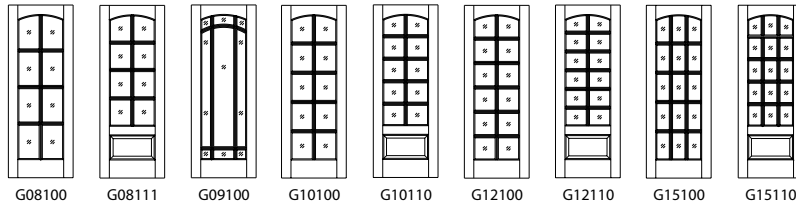

G08100 G08111 G09100 G10100 G10110 G12100 G12110 G15100 G15110

ARCH TOP DOORS

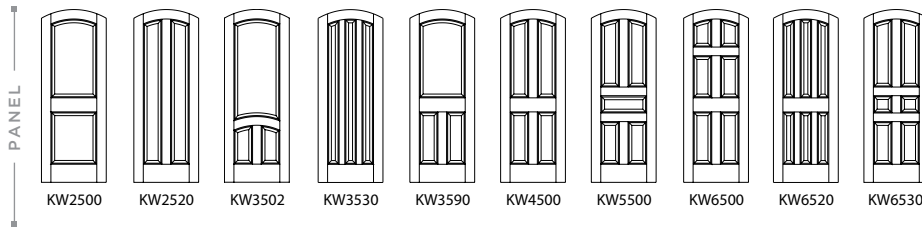

KW2500 KW2520 KW3502 KW3530 KW3590 KW4500 KW5500 KW6500 KW6520 KW6530

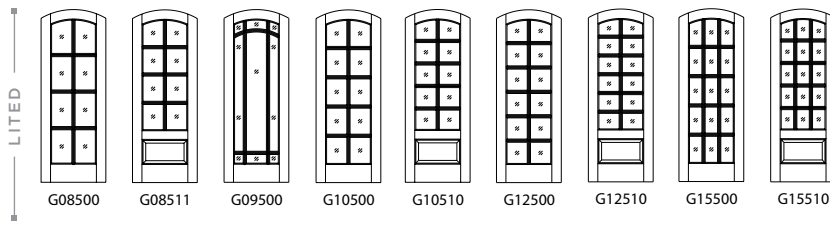

G08500 G08511 G09500 G10500 G10510 G12500 G12510 G15500 G15510

HALF ROUND TOP DOORS

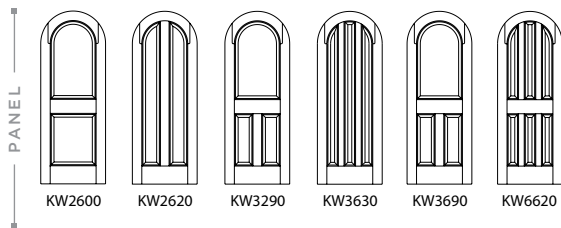

KW2600 KW2620 KW3290 KW3630 KW3690 KW6620





MODERN FARMHOUSE

CLASSIC STYLE WITH A MODERN TOUCH.

Recommended Door Profile

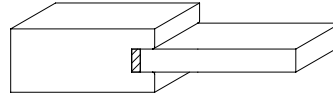

D13-403

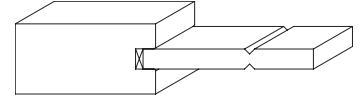

D13-403 Vee Groove

Courtesy - Loyd Builders, Apex, NC

PANEL DOORS

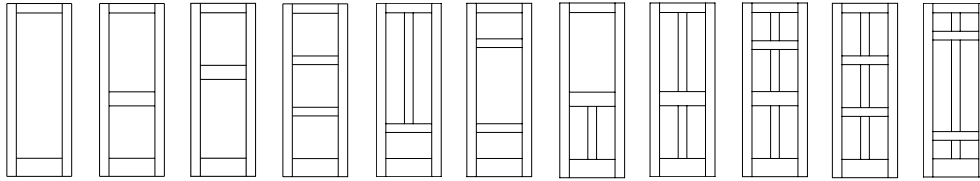

KW1000 KW2000 KW2030 KW3020 KW3060 KW3080 KW3090 KW4000 KW6000 KW6040 KW6060

LITED DOORS

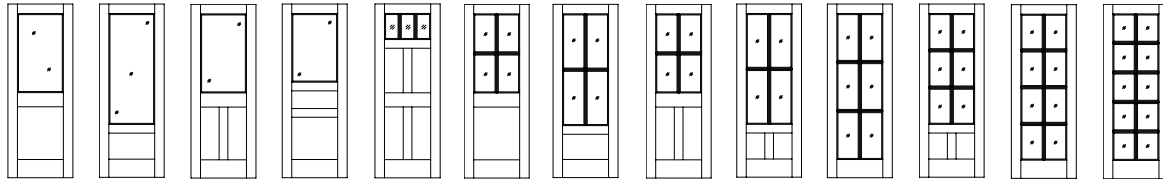

G01010 G01011 G01020 G01021 G03040 G04010 G04012 G04020 G04023 G06001 G06022 G08000 G10000

BARN DOORS

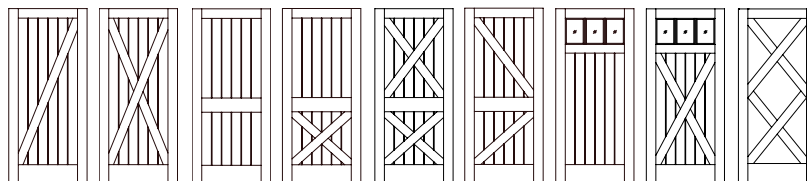

*KB1000 *KB1001 KB2000 *KB2001 *KB2002 *KB2003 ZO3000 *ZO3001 *KB1002

*Cross members are surface applied, flush with the face of the door. Available with "D" sticking only, flat panel designs.

See pages 38-41 for additional information on barn doors and barn door hardware.





TUDOR

ELEGANT, OLD WORLD CHARM.

Recommended Door Profile

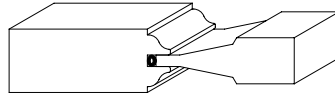

B11-341

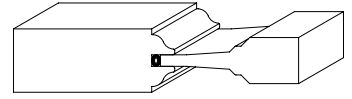

B11-641

PANEL DOORS

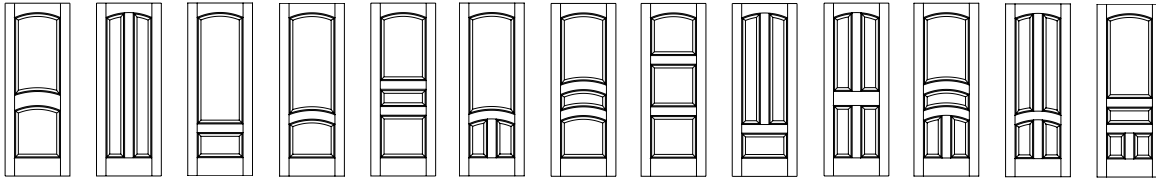

KW2110 KW2120 KW2150 KW2160 KW3100 KW3102 KW3110 KW3120 KW3160 KW4100 KW4101 KW4102 KW4103

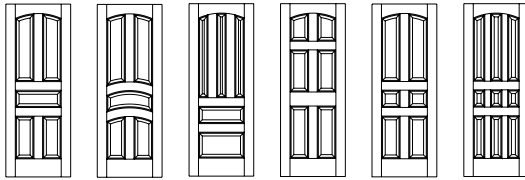

KW5100 KW5110 KW5170 KW6100 KW6130 KW9110

LITED DOORS

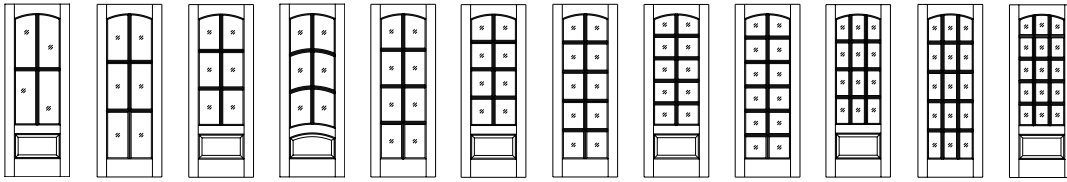

G04112 G06101 G06111 G06113 G08100 G08111 G10100 G10110 G12100 G12111 G15100 G15110

ARCH TOP DOORS

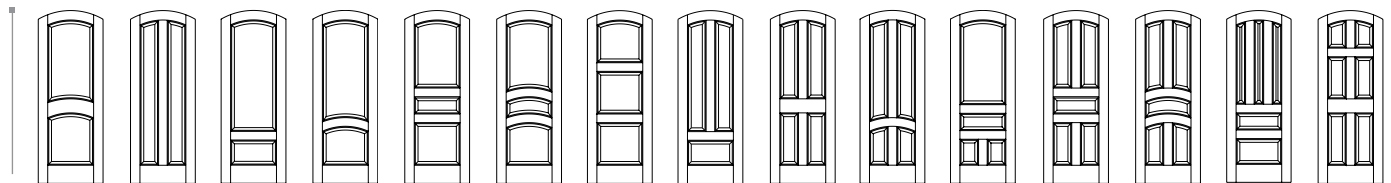

KW2510 KW2520 KW2550 KW2560 KW3500 KW3510 KW3520 KW3560 KW4500 KW4502 KW4503 KW5500 KW5510 KW5570 KW6500

PANEL

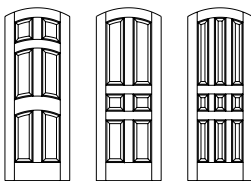

KW6510 KW6530 KW9510

LITED

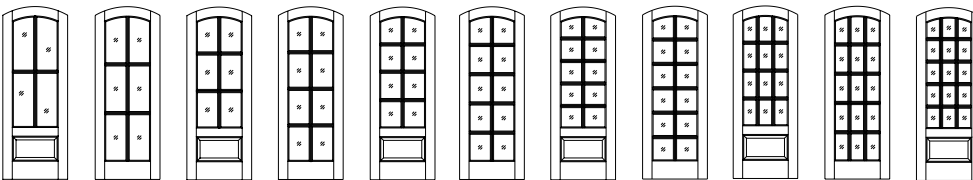

G04512 G06501 G06511 G08500 G08511 G10500 G10510 G12500 G12511 G15500 G15510





TUSCAN

INSPIRED BY ELEMENTS OF NATURE.

Recommended Door Profile

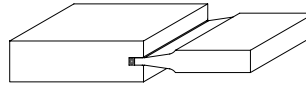

D11-131

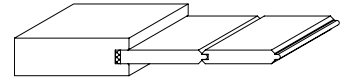

D13 with 1/2" T&V groove panel

PANEL DOORS

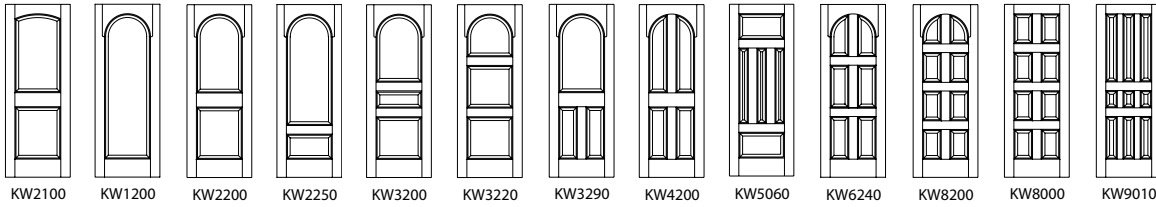

LITED DOORS



HALF ROUND TOP DOORS

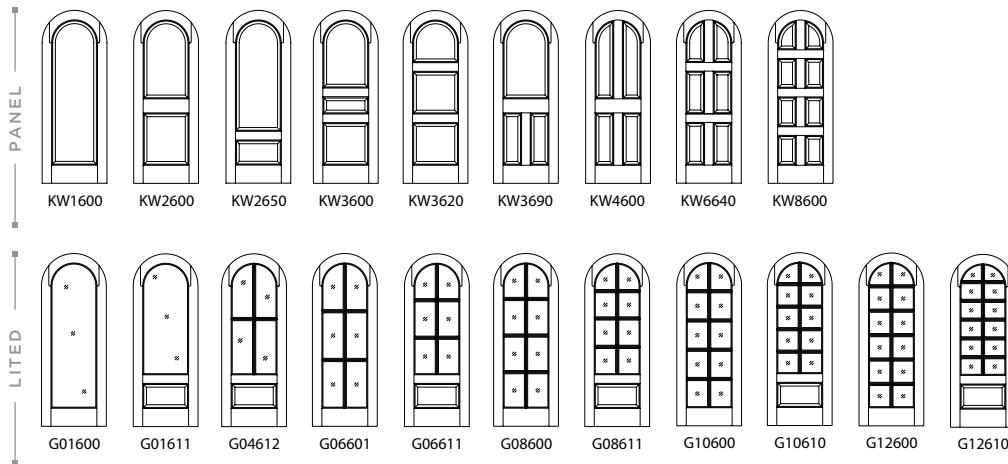





VICTORIAN

UNIQUE AND ABUNDANT WITH CHARACTER.

Recommended Door Profile

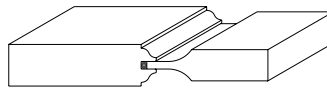

B11-241

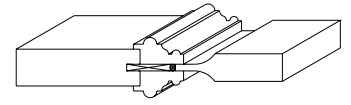

B-ADM 1" x 1-7/8" applied moulding

PANEL DOORS

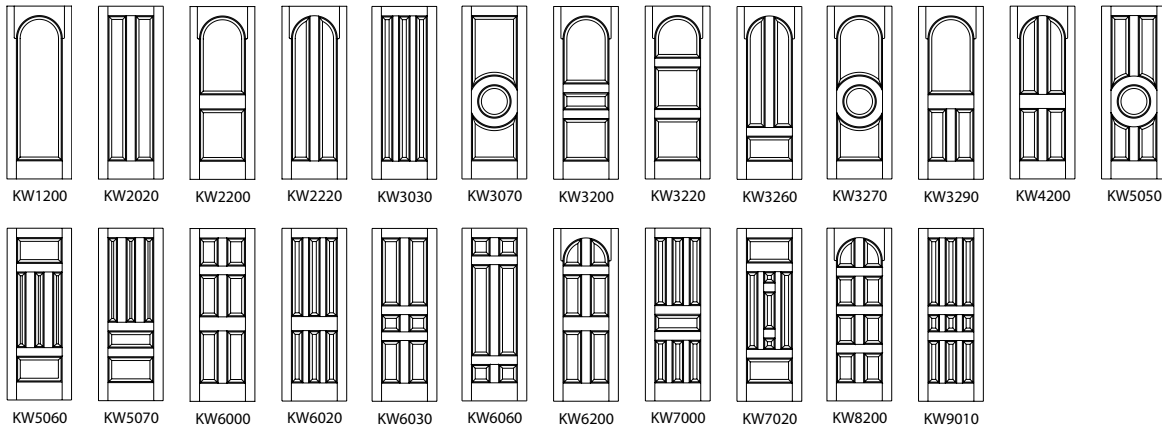

LITED DOORS

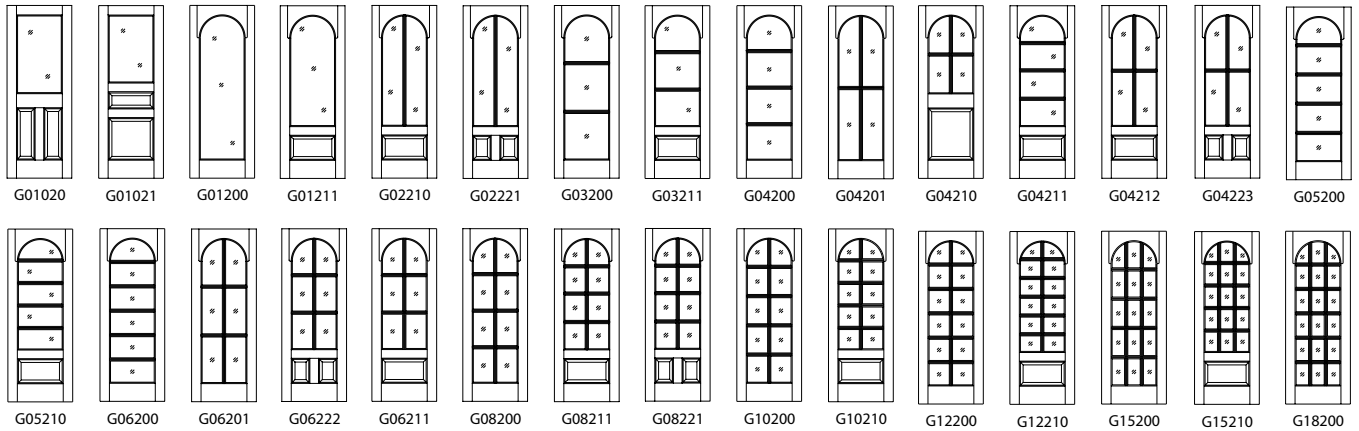

HALF ROUND TOP DOORS

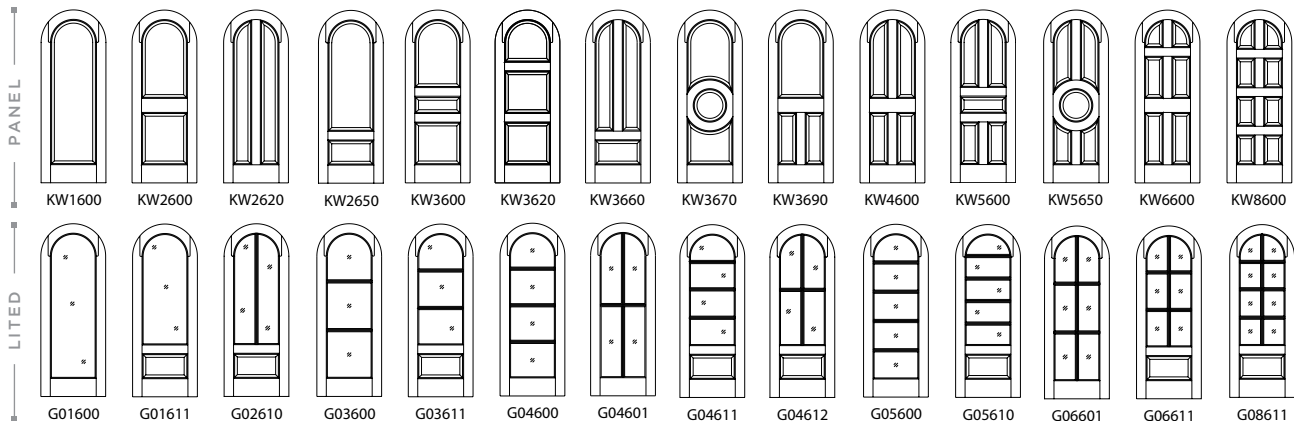

REFERENCE GUIDE - PANEL DOORS

1-PANEL

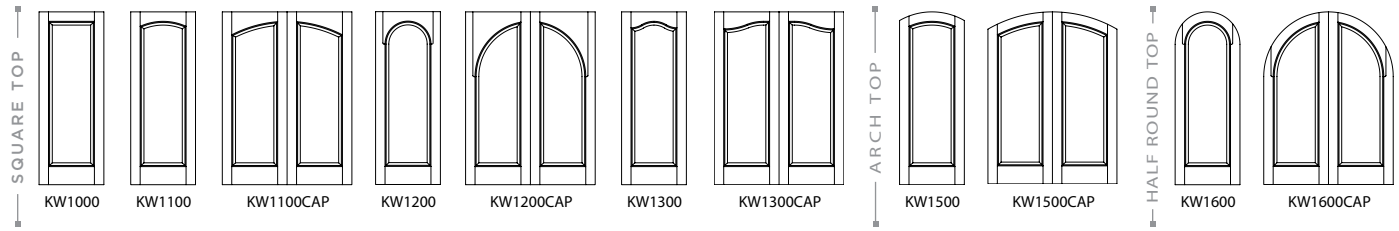

2-PANEL

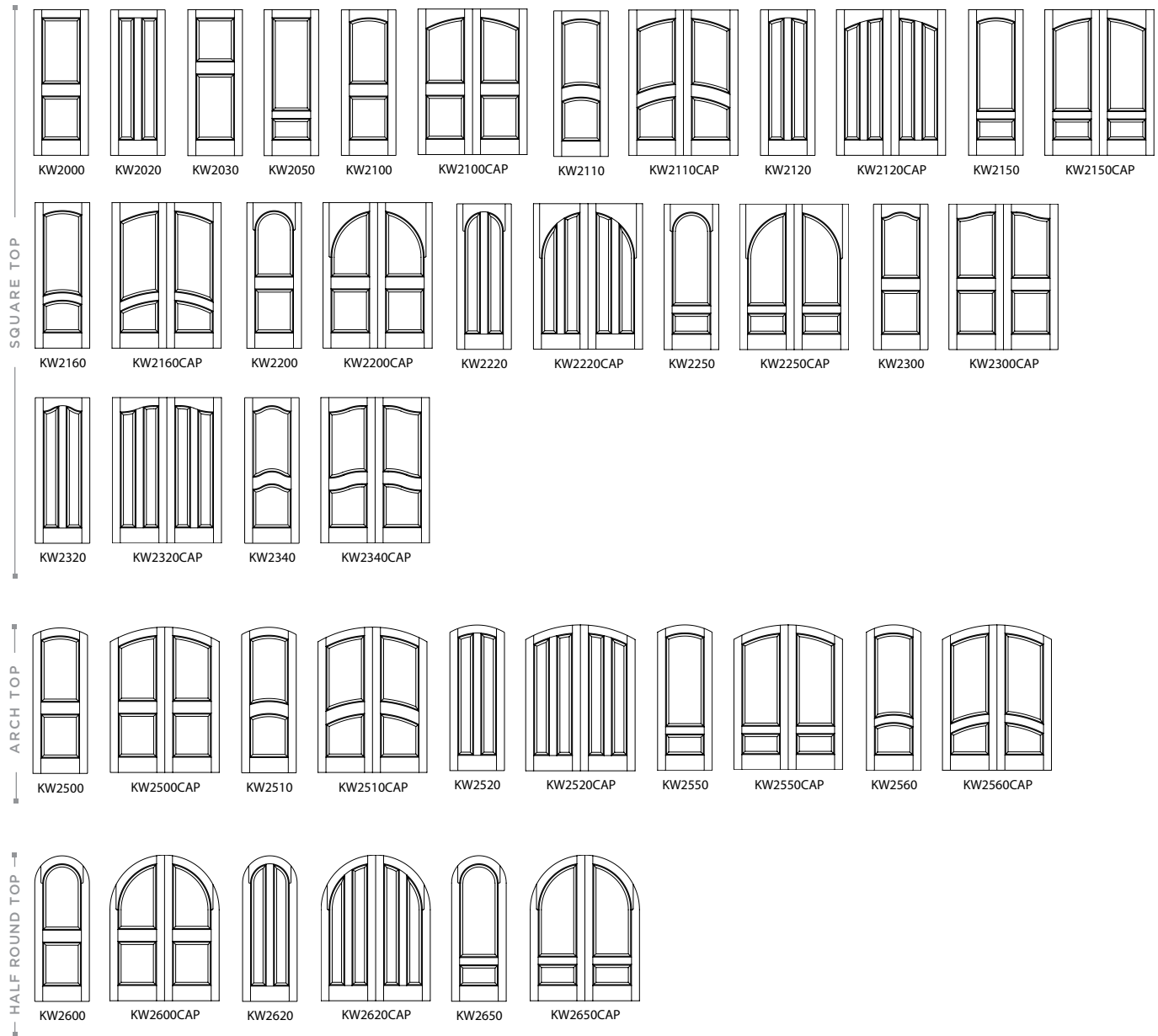

REFERENCE GUIDE - PANEL DOORS

3-PANEL

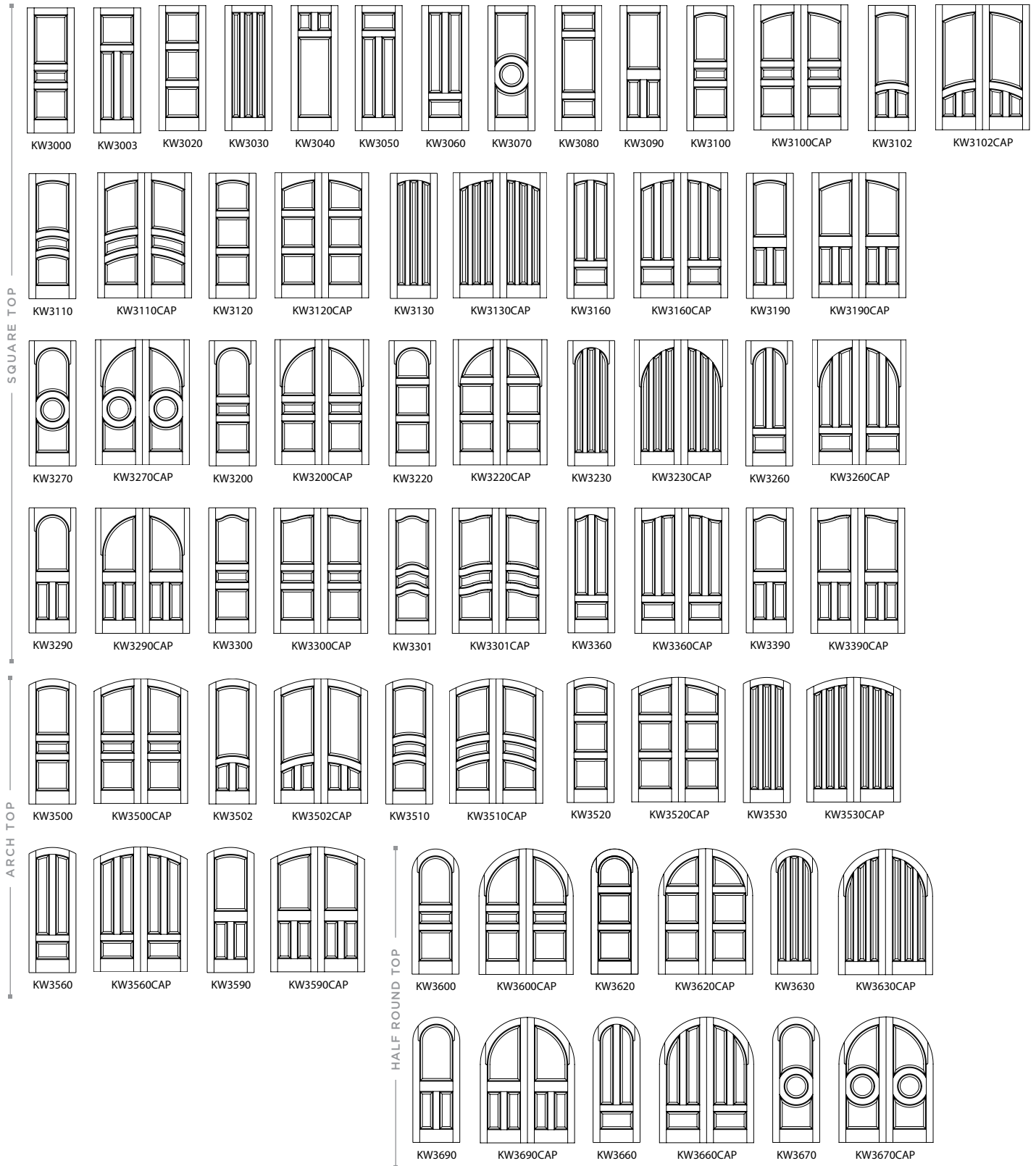

REFERENCE GUIDE - PANEL DOORS

4-PANEL

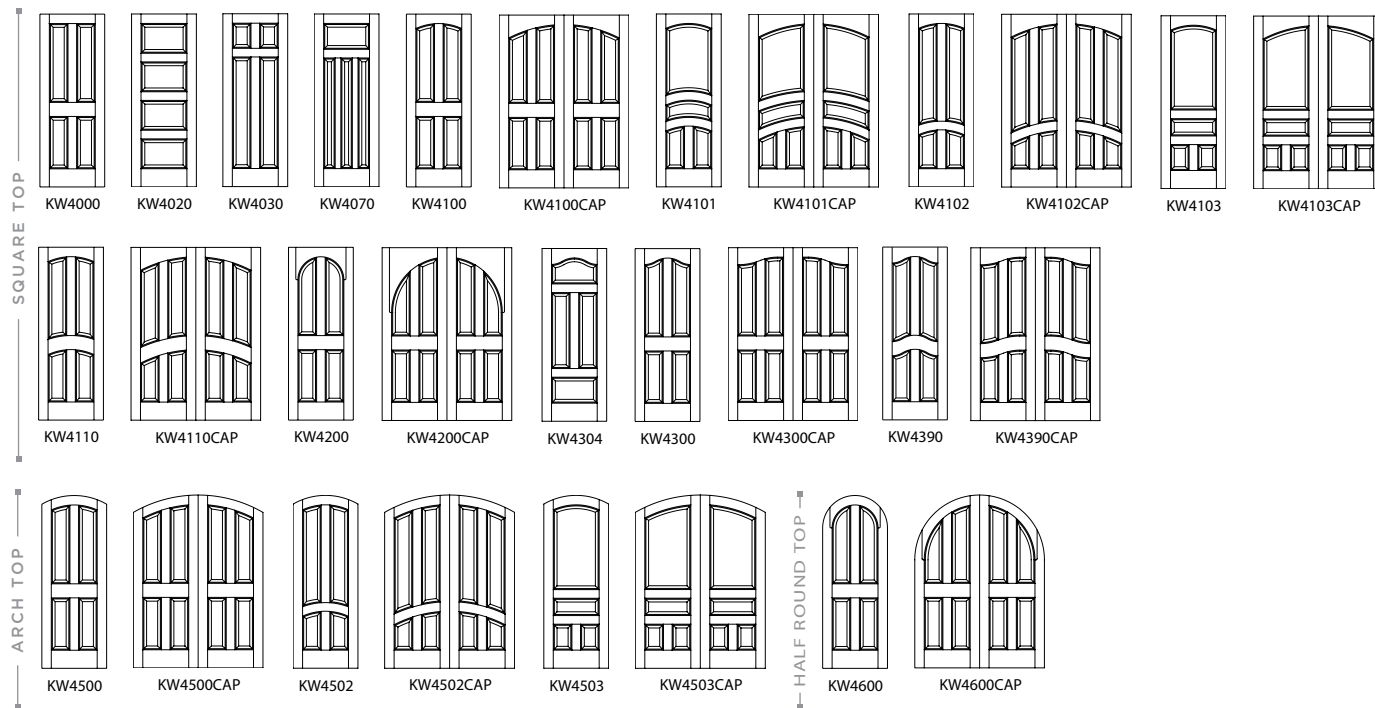

5-PANEL

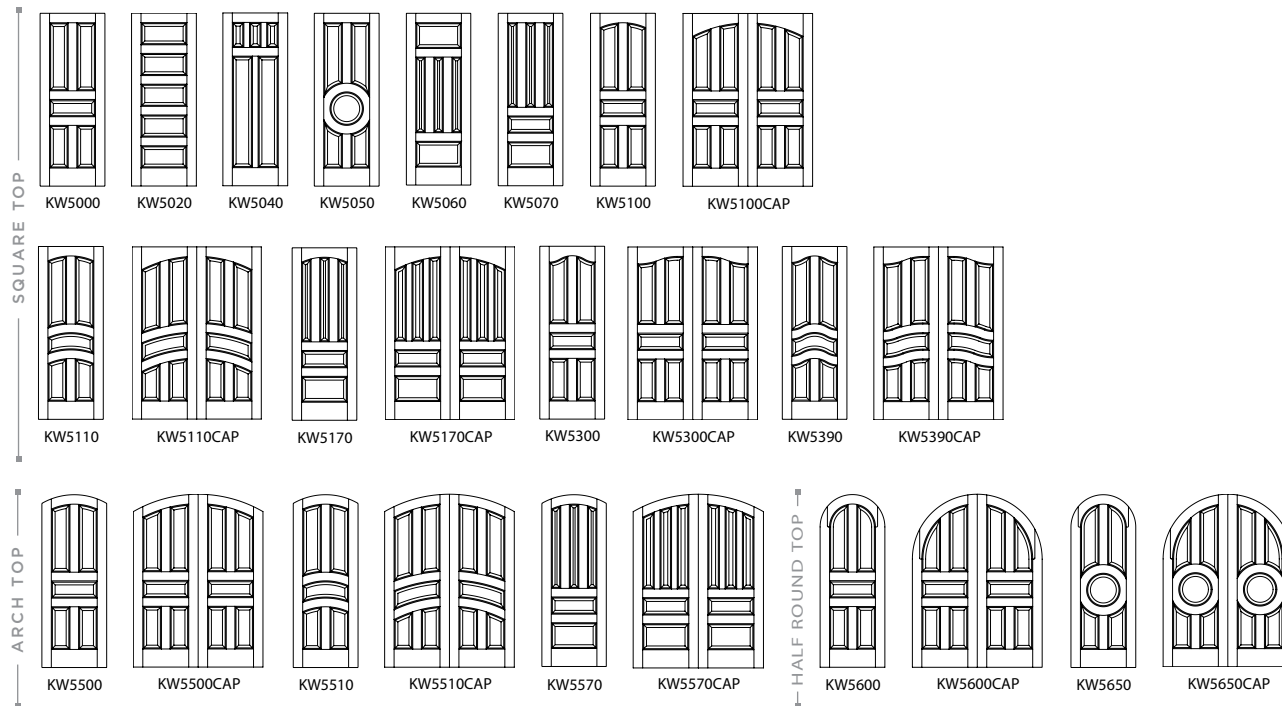

REFERENCE GUIDE - PANEL DOORS

6-PANEL

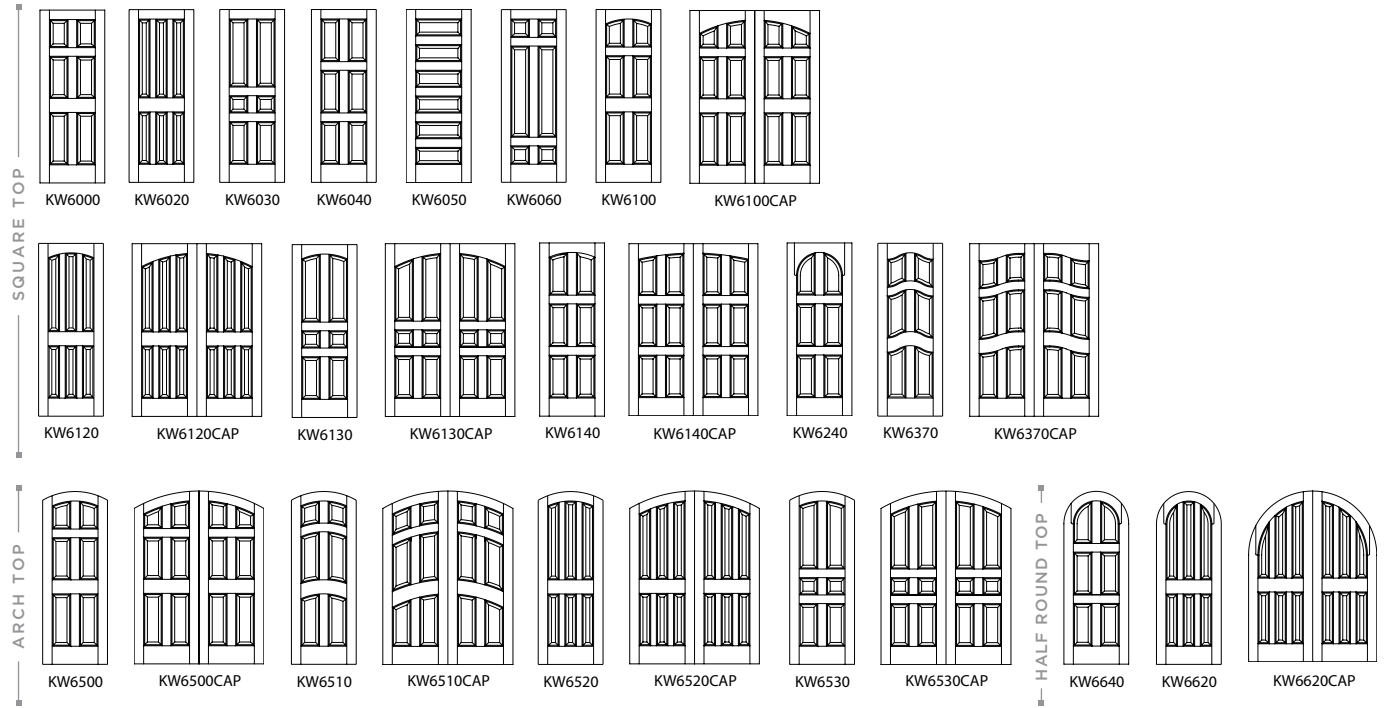

7-PANEL

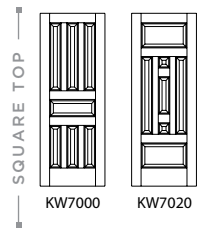

8-PANEL



9-PANEL

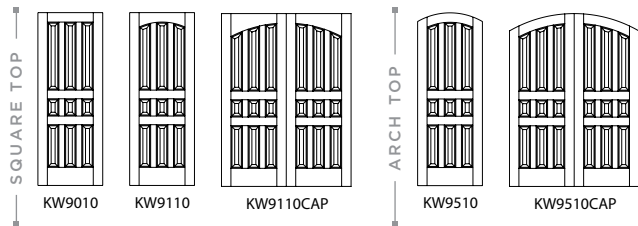

KW8000, D23-403, White Oak

LOUVER AND DUTCH DOORS

LOUVER DOORS

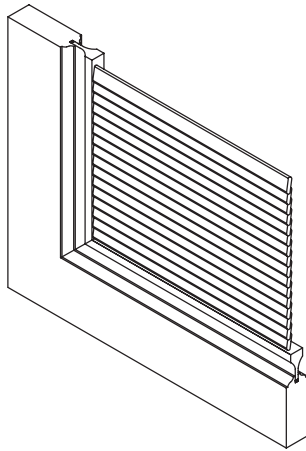
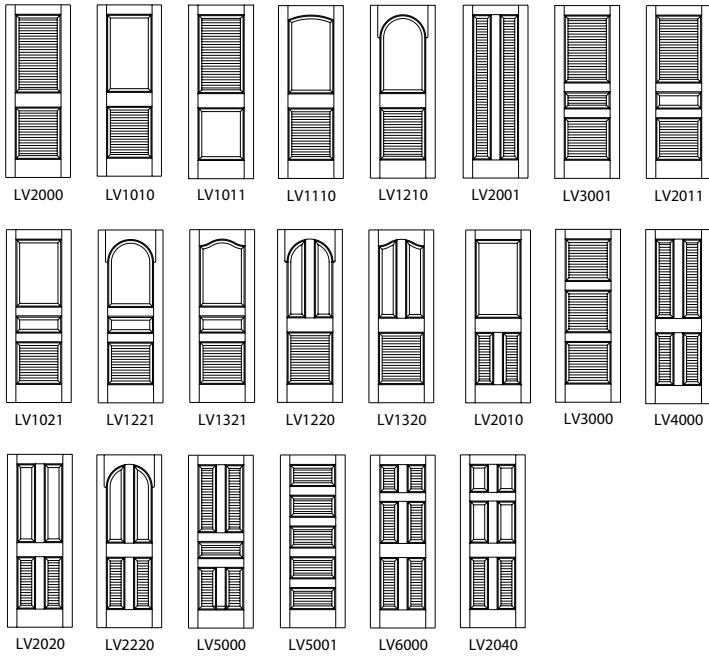

(From L to R) LV2000, LV2001 Poplar

Our louvered doors are manufactured with a unique raised panel louver design, where the louvers are set into a raised panel frame. Unlike traditional louver door construction, there is no end-play, which provides stability and eliminates rattles.

This method of construction offers you the ability to match your louvered door sticking and panel raise to your paneled doors, maintaining a consistent design throughout your project.

DUTCH DOORS

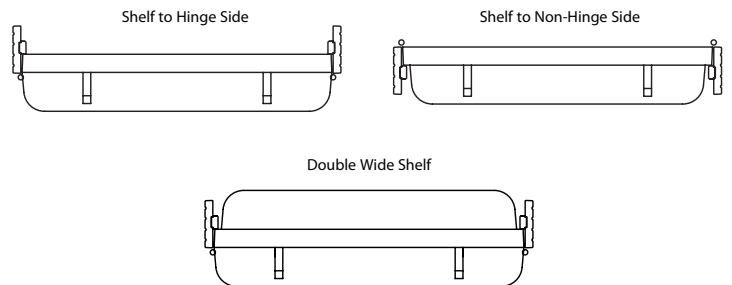

1-3/8" INTERIOR PANEL & RAIL OPTIONS

1-3/8" DOORS - PANEL RAIL COMBINATIONS - 1/4" GROOVE

Images are shown at 35% of size.

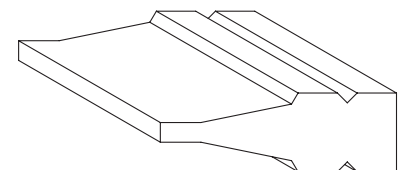
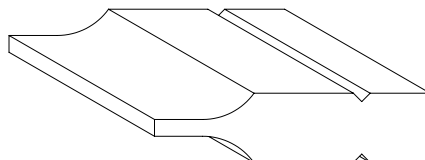
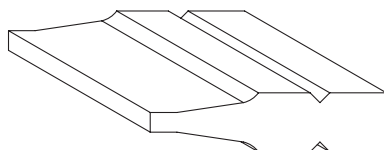
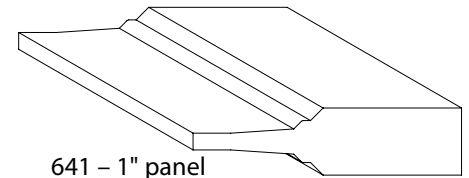
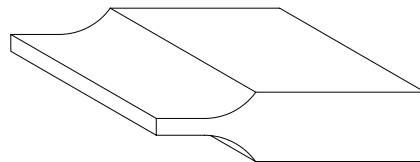
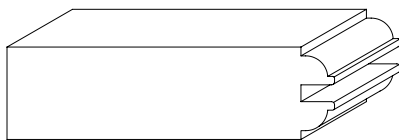
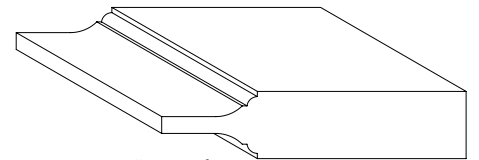
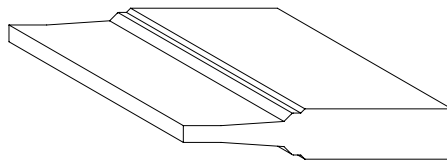
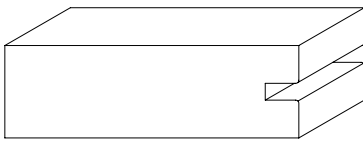
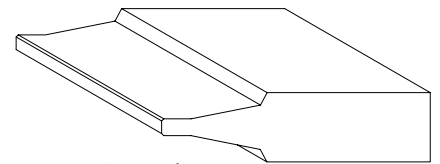
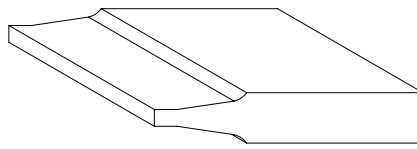
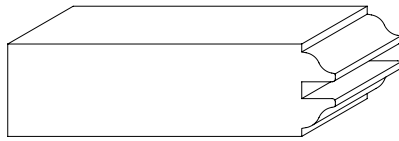
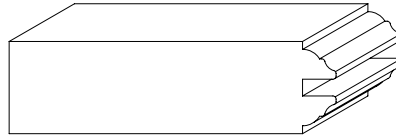
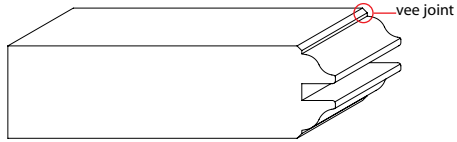

1-3/8" INTERIOR PANEL & RAIL OPTIONS

1-3/8" DOORS - PANEL RAIL COMBINATIONS - 1/2" GROOVE

Images are shown at 35% of size.

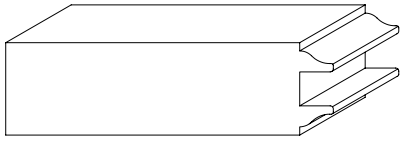

B13

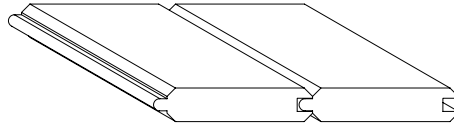

16-DP-TVG, 1/2" T&V Groove
(Plank width varies based on door style)

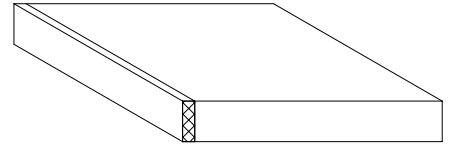

403 - 1/2" Flat Panel
Panel may be veneer or solid

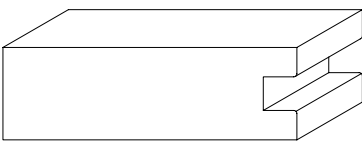

D13

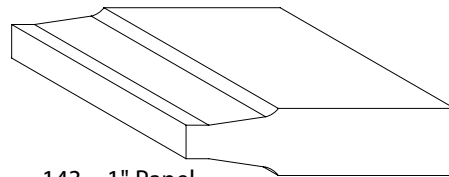

143 - 1" Panel

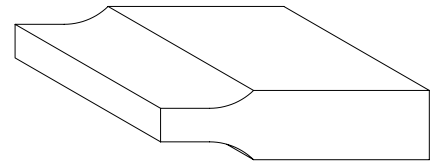

243 - 1" Panel

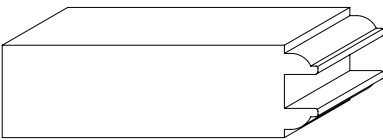

E13

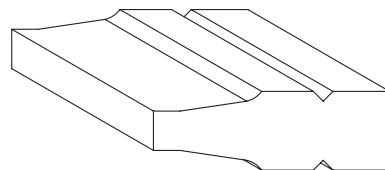

143 Vee Groove - 1" panel
1/4" w. x 1/8" d. vee groove

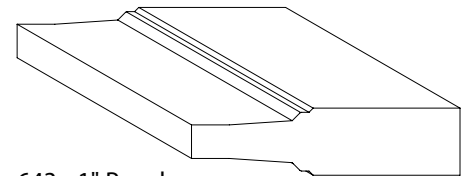

643 - 1" Panel

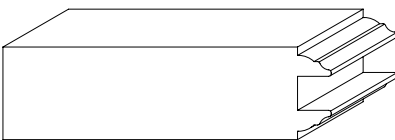

F13

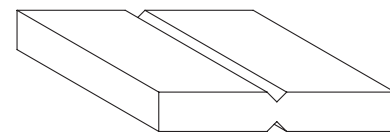

403 Vee Groove - 1/2" panel
1/4" w. x 1/8" d. vee groove

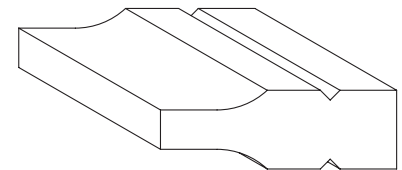

243 Vee Groove - 1" panel
1/4" w. x 1/8" d. vee groove

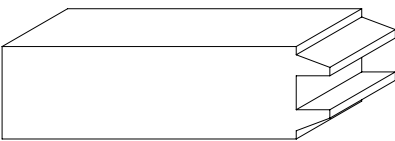

G13

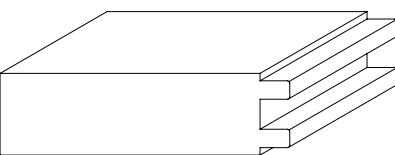

H13

1-3/4" INTERIOR PANEL & RAIL OPTIONS

1-3/4" DOORS - PANEL RAIL COMBINATIONS - 1/4" GROOVE

Images are shown at 35% of size.

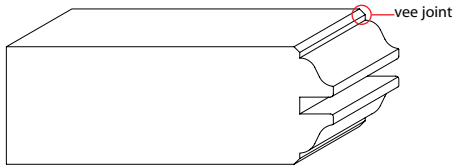

A21

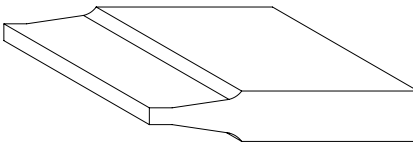

131 - 3/4" panel

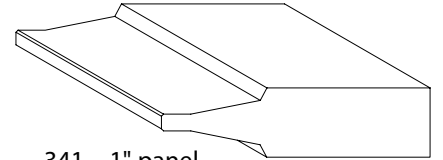

341 - 1" panel

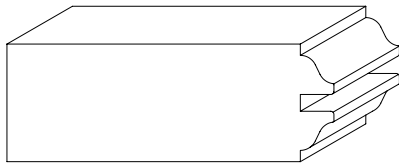

B21

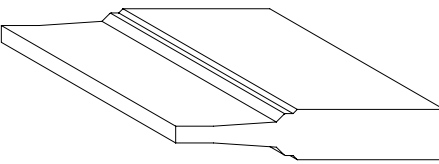

631 - 3/4" panel

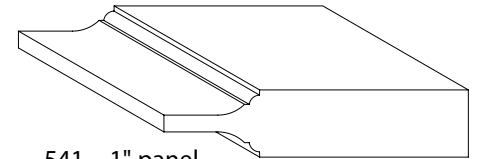

541 - 1" panel

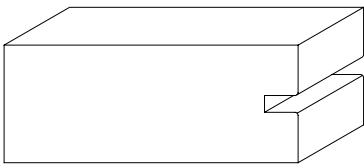

D21

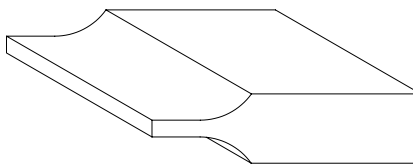

241 - 1" panel

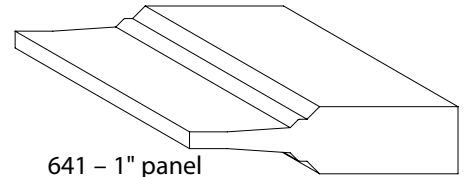

641 - 1" panel

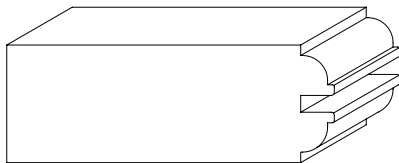

E21

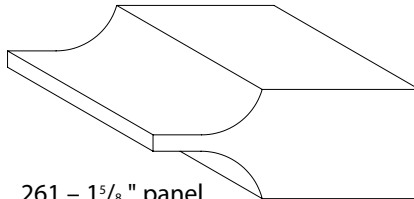

261 - 1⁵/₈" panel

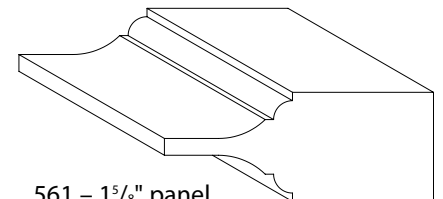

561 - 1⁵/₈" panel

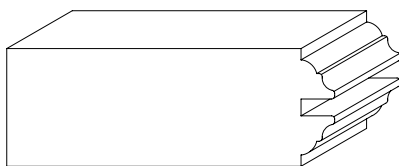

F21

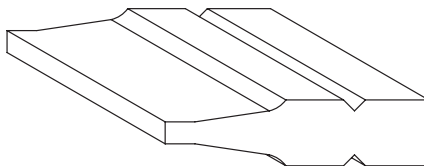

131 Vee Groove - 3/4" panel
1/4" w. x 1/8" d. vee groove

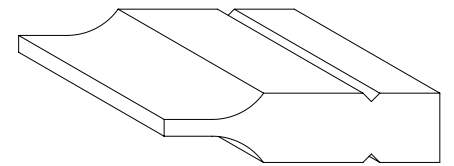

241 Vee Groove - 1" panel
1/4" w. x 1/8" d. vee groove

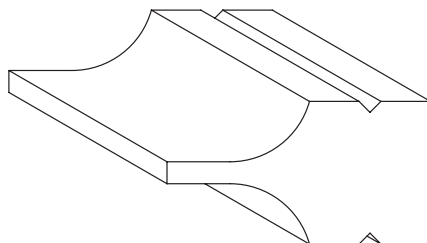

261 Vee Groove - 1⁵/₈" panel
1/4" w. x 1/8" d. vee groove

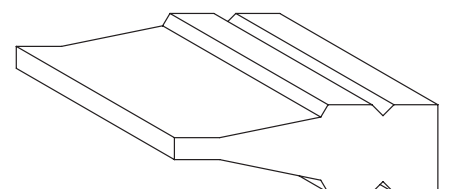

341 Vee Groove - 1" panel
1/4" w. x 1/8" d. vee groove

1-3/4" INTERIOR PANEL & RAIL OPTIONS

1-3/4" DOORS - PANEL RAIL COMBINATIONS - 1/2" GROOVE

Images are shown at 35% of size.

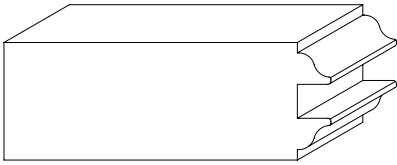

B23

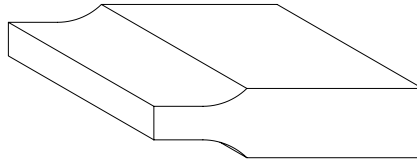

243 - 1" Panel

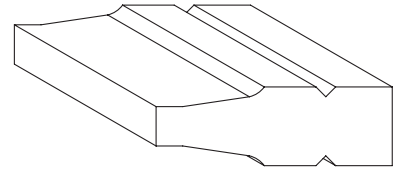

143 Vee Groove - 1" panel
1/4" w. x 1/8" d. vee groove

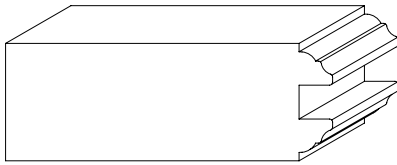

F23

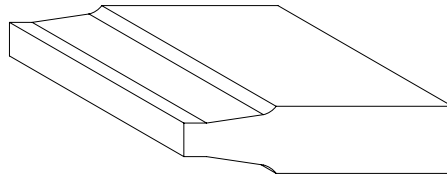

143 - 1" Panel

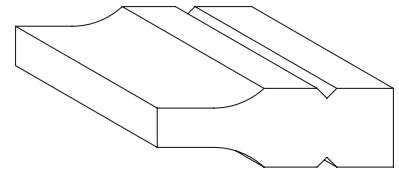

243 Vee Groove - 1" panel
1/4" w. x 1/8" d. vee groove

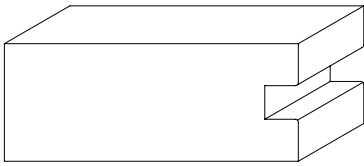

D23

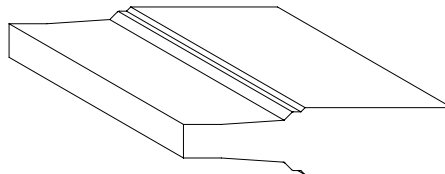

643 - 1" Panel

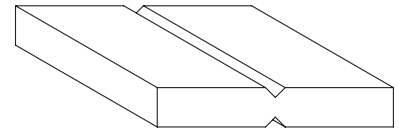

403 Vee Groove - 1/2" panel
1/4" w. x 1/8" d. vee groove

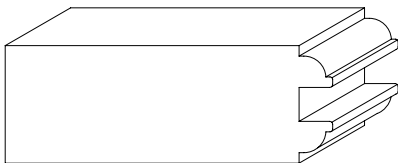

E23

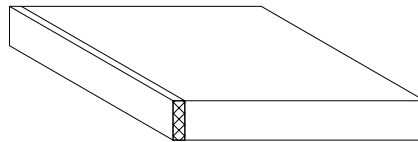

403 - 1/2" Flat Panel
Panel may be veneer or solid

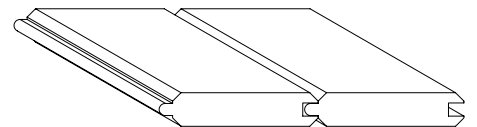

1/2" T&V Groove
(Plank width varies based on door style)

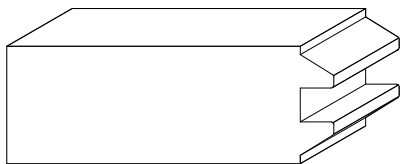

G23

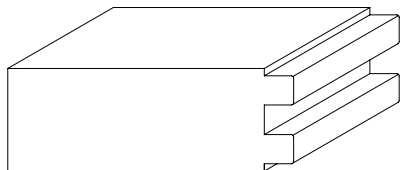

H23

1-3/4" EXTERIOR PANEL & RAIL OPTIONS

1-3/4" DOORS - PANEL RAIL COMBINATIONS - 5/8" GROOVE

Images are shown at 35% of size.

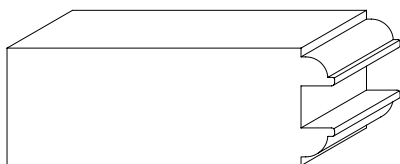
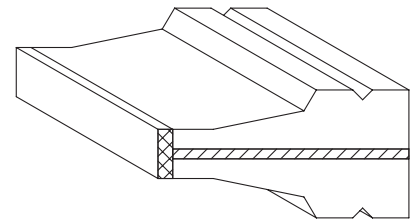
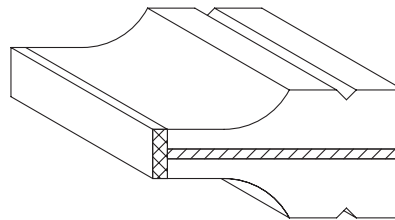
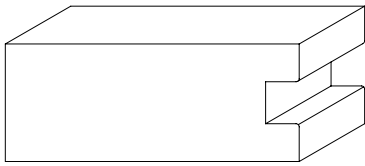
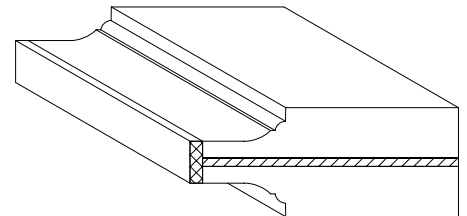
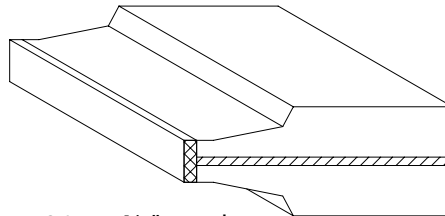
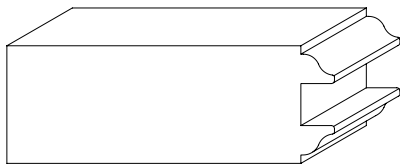
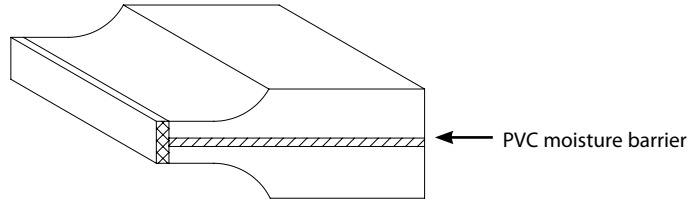
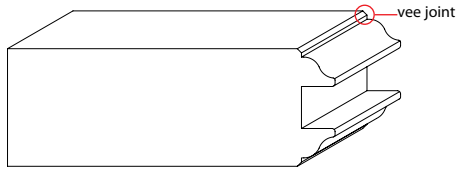

1-3/4" DOORS - PANEL RAIL COMBINATIONS - 1" GROOVE

Images are shown at 35% of size.

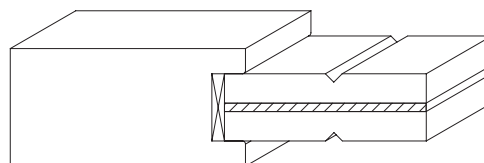
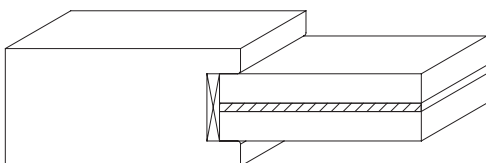

2-1/4" INTERIOR PANEL & RAIL OPTIONS

2-1/4" DOORS - PANEL RAIL COMBINATIONS - 1/4" GROOVE

Images are shown at 35% of size.

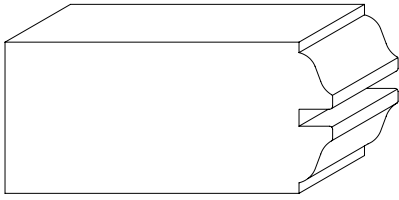

B51

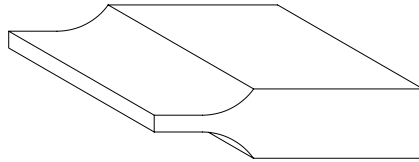

241 - 1" panel

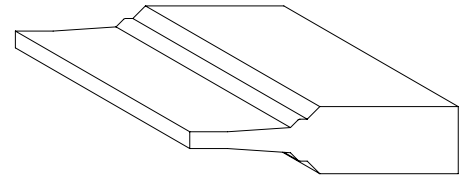

641 - 1" panel

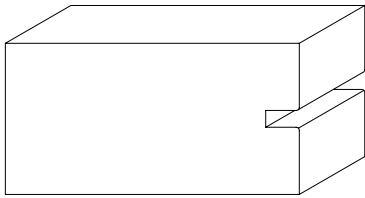

D51

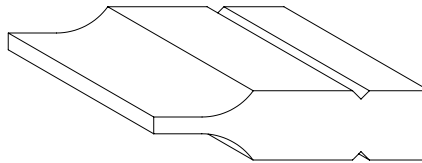

241 Vee Groove - 1" panel
1/4" w. x 1/8" d. vee groove

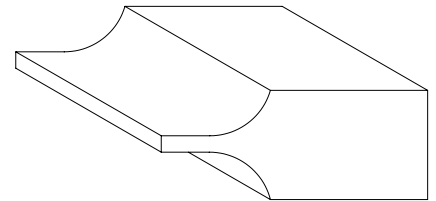

261 - 1⁵/₈" panel

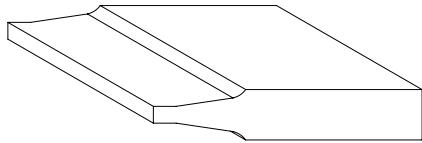

131 - 3/4" panel

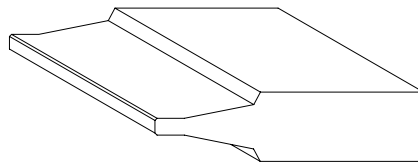

341 - 1" panel

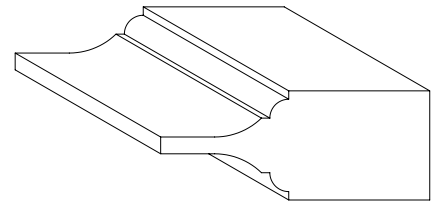

561 - 1⁵/₈" panel

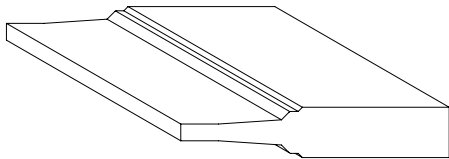

631 - 3/4" panel

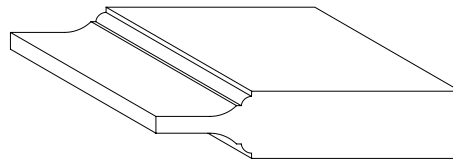

541 - 1" panel

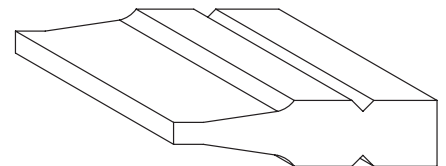

131 Vee Groove - 3/4" panel
1/4" w. x 1/8" d. vee groove

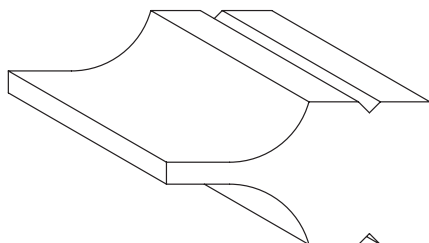

261 Vee Groove - 1⁵/₈" panel
1/4" w. x 1/8" d. vee groove

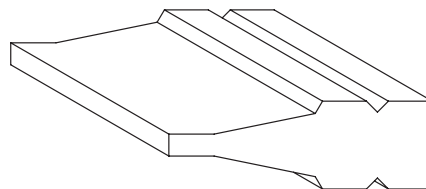

341 Vee Groove - 1" panel
1/4" w. x 1/8" d. vee groove

2-1/4" EXTERIOR PANEL & RAIL OPTIONS

2-1/4" DOORS - PANEL RAIL COMBINATIONS - 3/4" GROOVE

Images are shown at 35% of size.

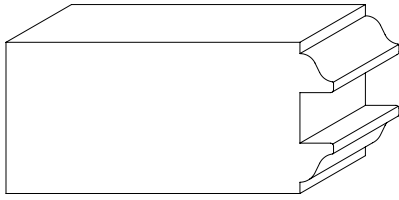

B55

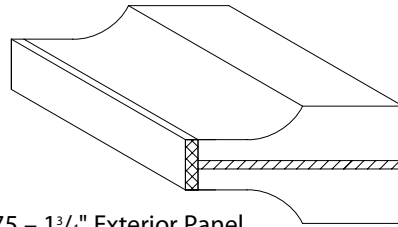

275 - 1³/₄" Exterior Panel

← PVC moisture barrier

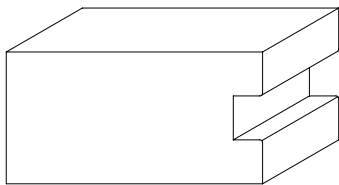

D55

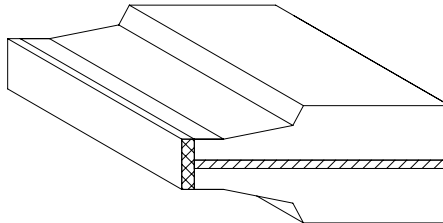

375 - 1³/₄" Panel

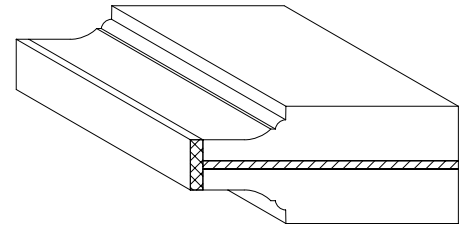

575 - 1³/₄" Panel

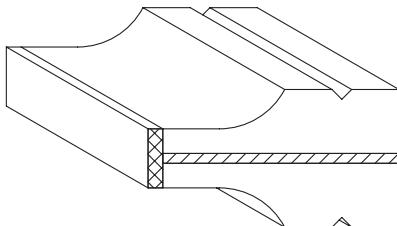

275 Vee Groove - 1³/₄" panel
1/4" w. x 1/8" d. vee groove

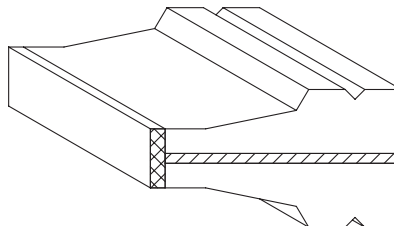

375 Vee Groove - 1³/₄" panel
1/4" w. x 1/8" d. vee groove

2-1/4" DOORS - PANEL RAIL COMBINATIONS - 1" GROOVE

Images are shown at 35% of size.

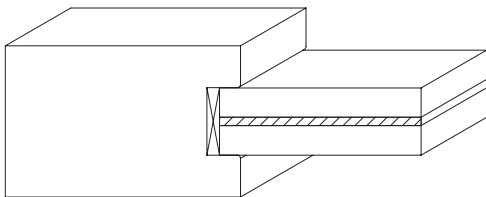

D57-447 - 1" panel

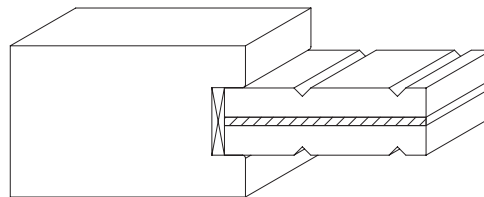

D57-447 Vee Groove - 1" panel
1/4" w. x 1/8" d. vee groove

APPLIED MOULDING OPTIONS

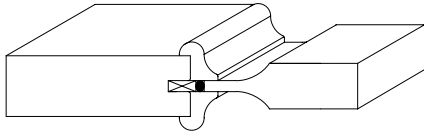

A-ADM $\frac{7}{8}$ " x $\frac{7}{8}$ " applied moulding

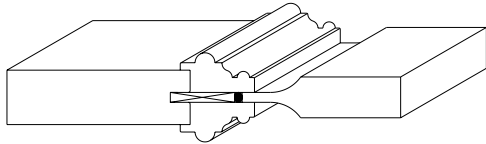

B-ADM 1" x $1\frac{7}{8}$ " applied moulding

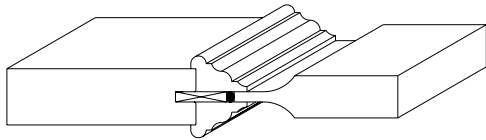

D-ADM $\frac{7}{8}$ " x $1\frac{3}{8}$ " applied moulding

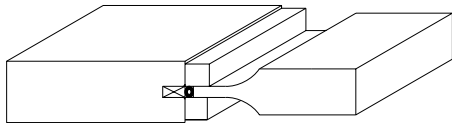

G-ADM $\frac{1}{2}$ " x $\frac{1}{2}$ " applied moulding

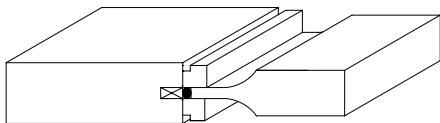

I-ADM $\frac{1}{2}$ " x $\frac{1}{2}$ " applied moulding

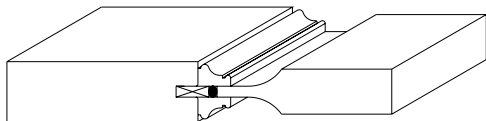

J-ADM $\frac{1}{2}$ " x $\frac{3}{4}$ " applied moulding



KW3060, 561 panel with B-ADM applied moulding, S01010 Sidelite (custom rail placement), Rain glass, Poplar

Add a unique design element to your Koetter Woodworking hardwood doors by choosing from our wide selection of applied moulding options.

Most mouldings can be modified to fit based on your individual door style and rail/panel selection (some limitations apply.) For illustration purposes, all applied mouldings are shown in combination with 1-3/8" rails and the 241 panel. Actual moulding size may vary based on your particular panel and rail selection.



SIGNATURE PRIME™ DOORS



When your project calls for paint grade doors, rely on the quality and craftsmanship found in Signature Prime™ doors from Koetter Woodworking.

Poplar stiles and rails combined with MDF panels are the perfect combination. Koetter Signature Prime™ doors feature face laminated, solid Poplar stiles and rails, providing superior screw holding power and reduced hinge wear over the life of the door. Since wood moves with the grain, the greatest expansion and contraction occurs in the widest components – the panels. MDF does not have grain memory, so it expands and contracts equal amounts in width and length, providing greater stability and uniform structural support.

The detailing in a Koetter Signature Prime™ door is visibly evident. Profiles are precision machined with diamond and carbide tooling, providing crisp, well-defined profile features. Each door is primed by hand with a high-solid content primer which provides more thorough coverage, while maintaining the precise detail of the profile.



Shown: D13-403



Shown: B11-241

FIRE RATED STILE AND RAIL WOOD DOORS



Koetter Woodworking offers an unmatched selection of fire rated stile and rail doors, engineered to match our extensive offering of non-rated doors. Choose from numerous panel and rail options in one of nine highly recognized architectural styles. Doors are available as slabs or pre-hung units in accompanying fire rated wood jambs.

Please visit our web site at www.koetterwoodworking.com to view some of the most frequently asked questions regarding Koetter Brand Certified fire rated doors and jambs.

ADDITIONAL INFORMATION REGARDING FIRE DOOR AVAILABILITY:

	20-minute	45-minute	60-minute	90-minute
Category	Category A Positive Pressure or Category B Neutral Pressure	Category A Positive Pressure or Category B Neutral Pressure	Category A Positive Pressure or Category B Neutral Pressure	Category A Positive Pressure or Category B Neutral Pressure
Thickness	1-3/4" or 2-1/4"	1-3/4" or 2-1/4"	1-3/4" or 2-1/4"	1-3/4" or 2-1/4"
Door Species	Alder, Knotty Alder, Cherry, Fir, Hard Maple, Hickory, KW Mahogany, Poplar (Raw, Primed, or with MDF panels*), Red Oak, Walnut, White Oak	Alder, Knotty Alder, Cherry, Fir, Hard Maple, Hickory, KW Mahogany, Poplar (Raw, Primed, or with MDF panels*), Red Oak, Walnut, White Oak	Alder, Knotty Alder, Cherry, Fir, Hard Maple, Hickory, KW Mahogany, Poplar (Raw, Primed, or with MDF panels*), Red Oak, Walnut, White Oak	Alder, Knotty Alder, Cherry, Fir, Hard Maple, Hickory, KW Mahogany, Poplar (Raw, Primed, or with MDF panels*), Red Oak, Walnut, White Oak
Door Styles	Square or Radius Top Panel Doors	Square or Radius Top Panel Doors	Square or Radius Top Panel Doors	Square top panel doors only
Maximum Door Width	4'0" Singles 7'0" Pairs	4'0" Singles	4'0" Singles	4'0" Singles
Maximum Door Height	8'0"	8'0"	8'0"	8'0"
Hanging	Available pre-hung in 20 minute wood jambs** Radius Top Doors Require a 45/60 Min jamb	Available pre-hung in 45 minute Fire Core wood jambs ** Single pre-hungs only	Available pre-hung in 60 minute Fire Core wood jambs ** Single pre-hungs only	Available pre-hung in 90 minute Fire Core wood jambs ** Single pre-hungs only
Low Density Jamb Species	Alder, Cherry, Fir, Knotty Alder & Poplar Maximum Size Singles 3'6" X 8'0" Doubles 5'6" X 8'0"	Alder, Knotty Alder, Cherry, Fir, Hard Maple, Hickory, KW Mahogany, Poplar, Red Oak, Walnut & White Oak	Alder, Knotty Alder, Cherry, Fir, Hard Maple, Hickory, KW Mahogany, Poplar, Red Oak, Walnut & White Oak	Alder, Knotty Alder, Cherry, Fir, Hard Maple, Hickory, KW Mahogany, Poplar, Red Oak, Walnut & White Oak
High Density Jamb Species	Hard Maple, Hickory, KW Mahogany, Red Oak, Walnut & White Oak Maximum Size Singles 4'0" X 8'0"** Doubles 7'0" X 8'0"**	Singles Only 4'0" X 8'0"	Singles Only 4'0" X 8'0"	Singles Only 4'0" X 8'0"

* MDF flat panels not available.

** Call for information in jamb and hang limitations. Some restrictions apply.



BARN DOORS & BARN DOOR HARDWARE

BARN DOOR STYLES

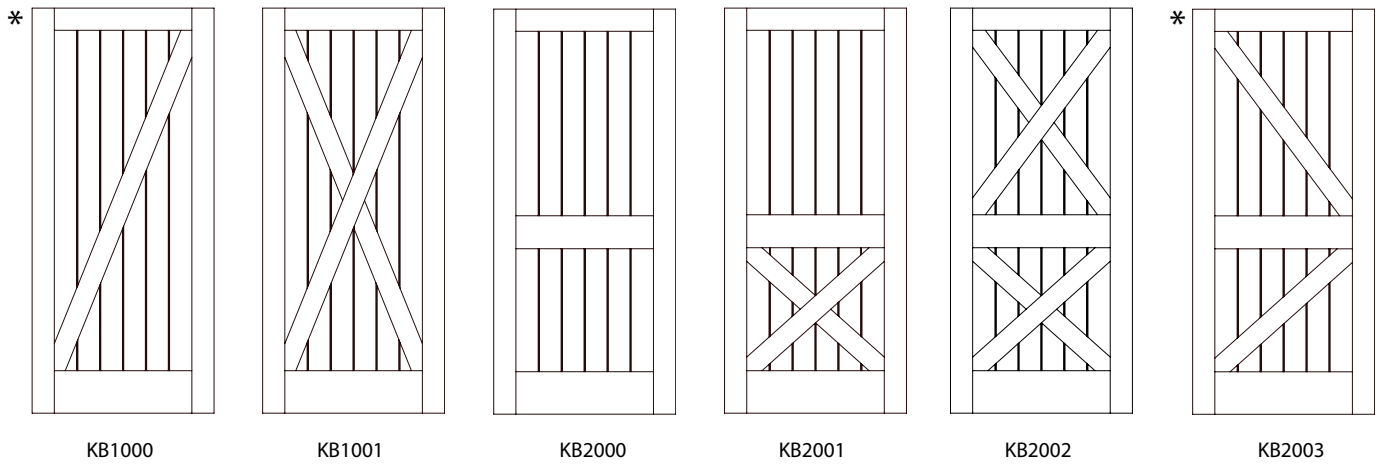

* - Designates hinge side on pre-hung units

LITED BARN DOOR STYLES

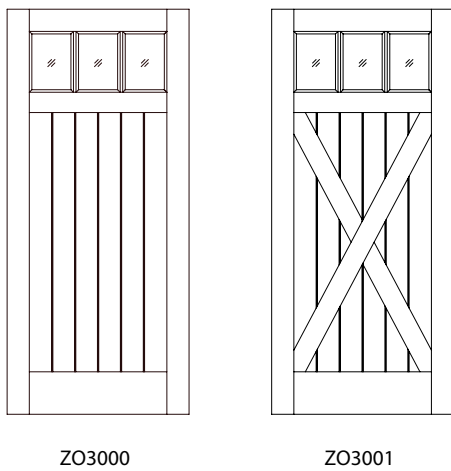

Additional door styles available upon request.



KW2000, Knotty Alder, J-ADM/341 v-groove (custom v-groove placement)

1-3/8" RAIL & PANEL/GLASS COMBINATIONS

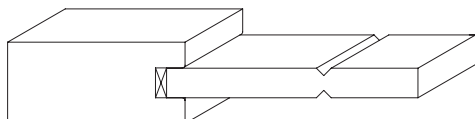

D13-403 vee groove panel

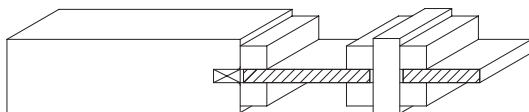

D1G with 1/4" glass

Cross members are surface applied, flush with the face of the door.

1-3/4" RAIL & PANEL/GLASS COMBINATIONS

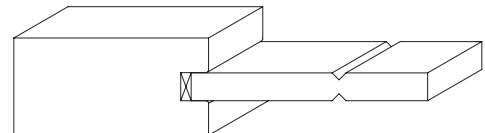

D23-403 vee groove panel

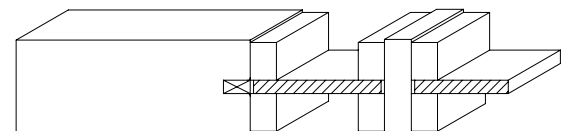

D2G with 1/4" glass

Cross members are surface applied, flush with the face of the door.



BARN DOORS & BARN DOOR HARDWARE

PRODUCT SPECIFICATIONS

- Choose from three popular styles, including straight strap, bent strap, and top of door strap.
- Stocked in three factory finishes - Matte Black, Bronze, and Satin Nickel.
- Hardware designed for both 1-3/8" and 1-3/4" thick doors, weighing up to 250 lbs.
- Kits include 96" track width, door straps, all mounting hardware, and floor guides.
- Perfect for closets, room dividers or passage door applications.
- Additional accessories available, including a selection of replacement hardware components as well as privacy locks and track connectors for bi-parting door applications.
- Ideal for openings 34" - 44" in width.

FINISH CODES

BR - Bronze
MB - Matte Black
SN - Satin Nickel



STRAIGHT STRAP HARDWARE KIT

HDW BD100K-09600-SN (shown)
HDW BD100K-09600-MB
HDW BD100K-09600-BR



TOP OF DOOR HARDWARE KIT

HDW BD101K-09600-SN
HDW BD101K-09600-MB
HDW BD101K-09600-BR (shown)



BENT STRAP HARDWARE KIT

HDW BD102K-09600-SN
HDW BD102K-09600-MB (shown)
HDW BD102K-09600-BR



REPLACEMENT STRAP - BENT

HDW BD552-BR (shown)
HDW BD552-MB
HDW BD552-SN



REPLACEMENT STRAP - STRAIGHT

HDW BD550-BR (shown)
HDW BD550-MB
HDW BD550-SN



BARN DOOR TRACK ONLY - 96"

HDW BD5000-09600-BR
HDW BD5000-09600-MB (shown)
HDW BD5000-09600-SN



TRACK JOINER KIT

HDW BD125-BR (shown)
HDW BD125-MB
HDW BD125-SN



BARN DOOR LAG SCREW

For Wall Spacers
HDW BD136-MB (shown)
HDW BD136-SN



FLOOR MOUNT GUIDES (PAIR)

HDW BD750
(black only - for non-grooved doors)



FLOOR MOUNT GUIDE

HDW BD750
(black only - bottom of door must be grooved)



BARN DOOR LATCH

HDW BD250-BR (shown)
HDW BD250-MB
HDW BD250-SN



TRACK STOPS (Left or Right)

HDW BD850-BR-L
HDW BD850-BR-R
HDW BD850-MB-L
HDW BD850-MB-R
HDW BD850-SN-L
HDW BD850-SN-R



BARN DOOR STRAP BOLT

HDW BD130-MB (for 1-3/8" door)
HDW BD130-SN (for 1-3/8" door)
HDW BD133-MB (for 1-3/4" door)
HDW BD133-SN (for 1-3/4" door)



EASY CLIP SOFT CLOSE ACCESSORY

HDW BDF960-6085-MB (black only)



WALL SPACER

HDW BD350-BR (shown)
HDW BD350-MB
HDW BD350-SN



ADJUSTABLE WALL MOUNT GUIDE

HDW BDWMGUIDE-MB
(black only - bottom of door must be grooved)



ANTI JUMP BLOCKS

HDW BD790 (pair)

REFERENCE GUIDE - LITED DOORS

1-LITE

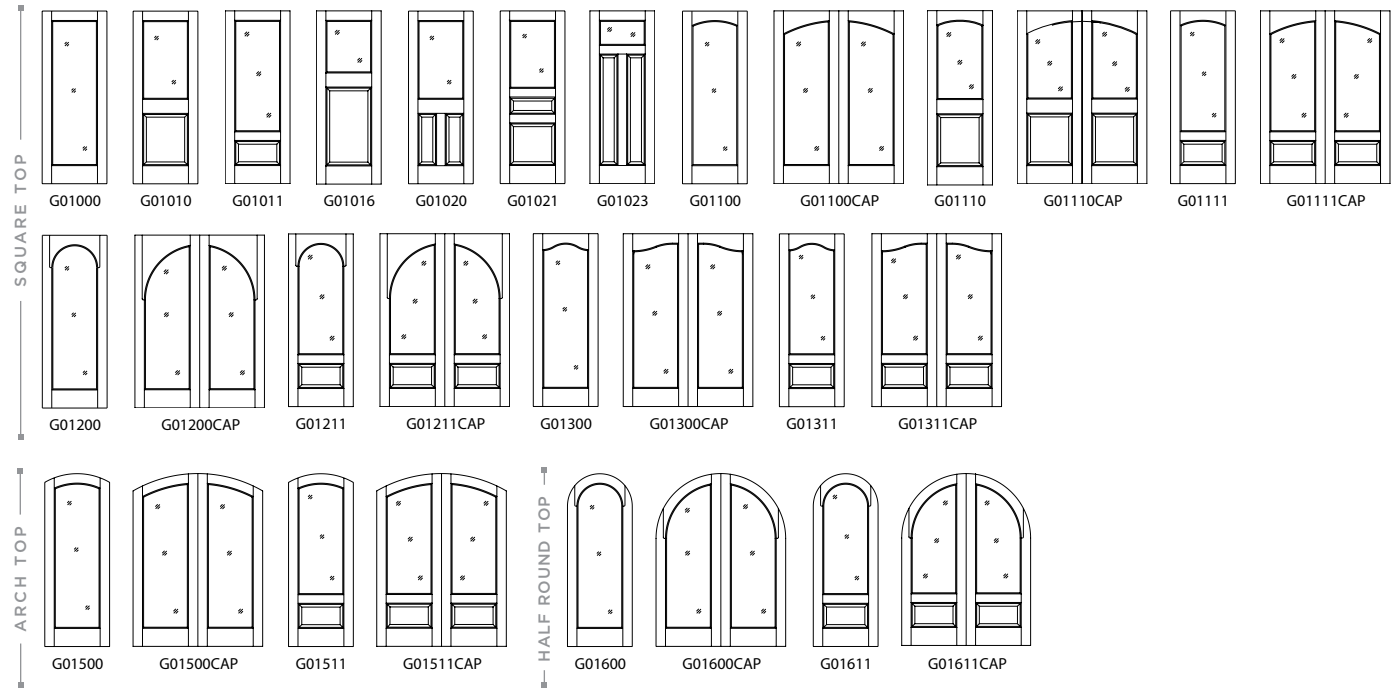

2-LITE

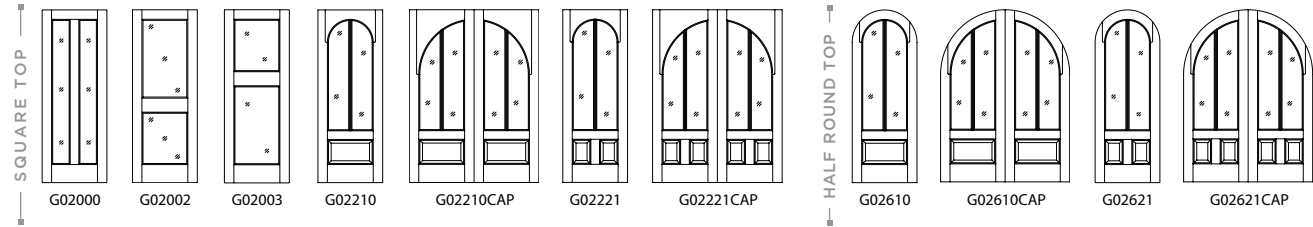

3-LITE

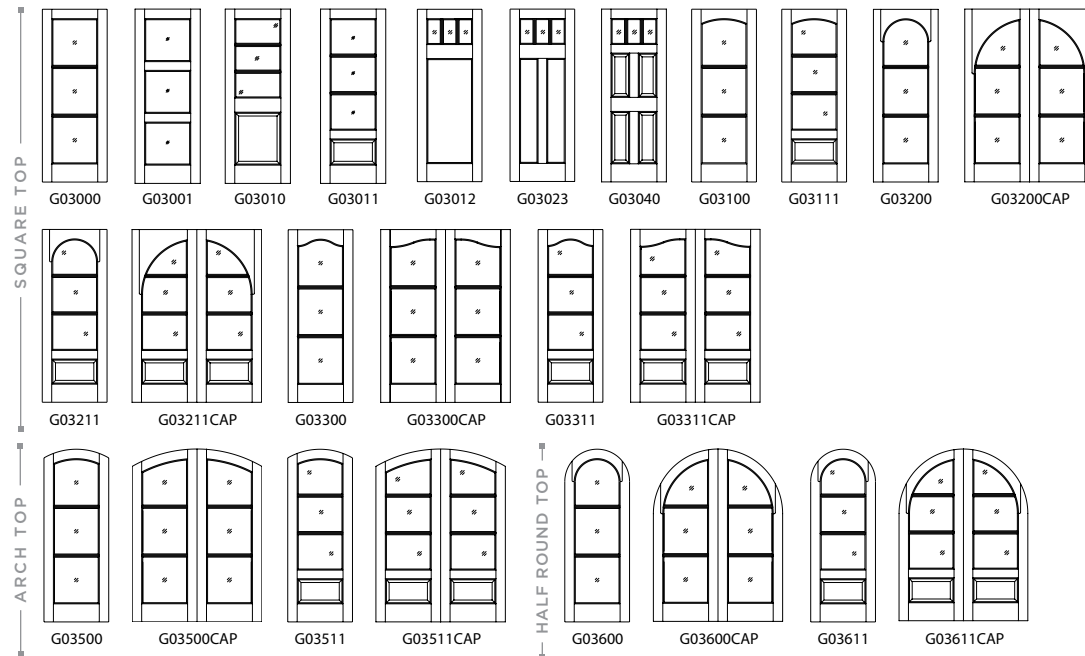

REFERENCE GUIDE - LITED DOORS

4-LITE

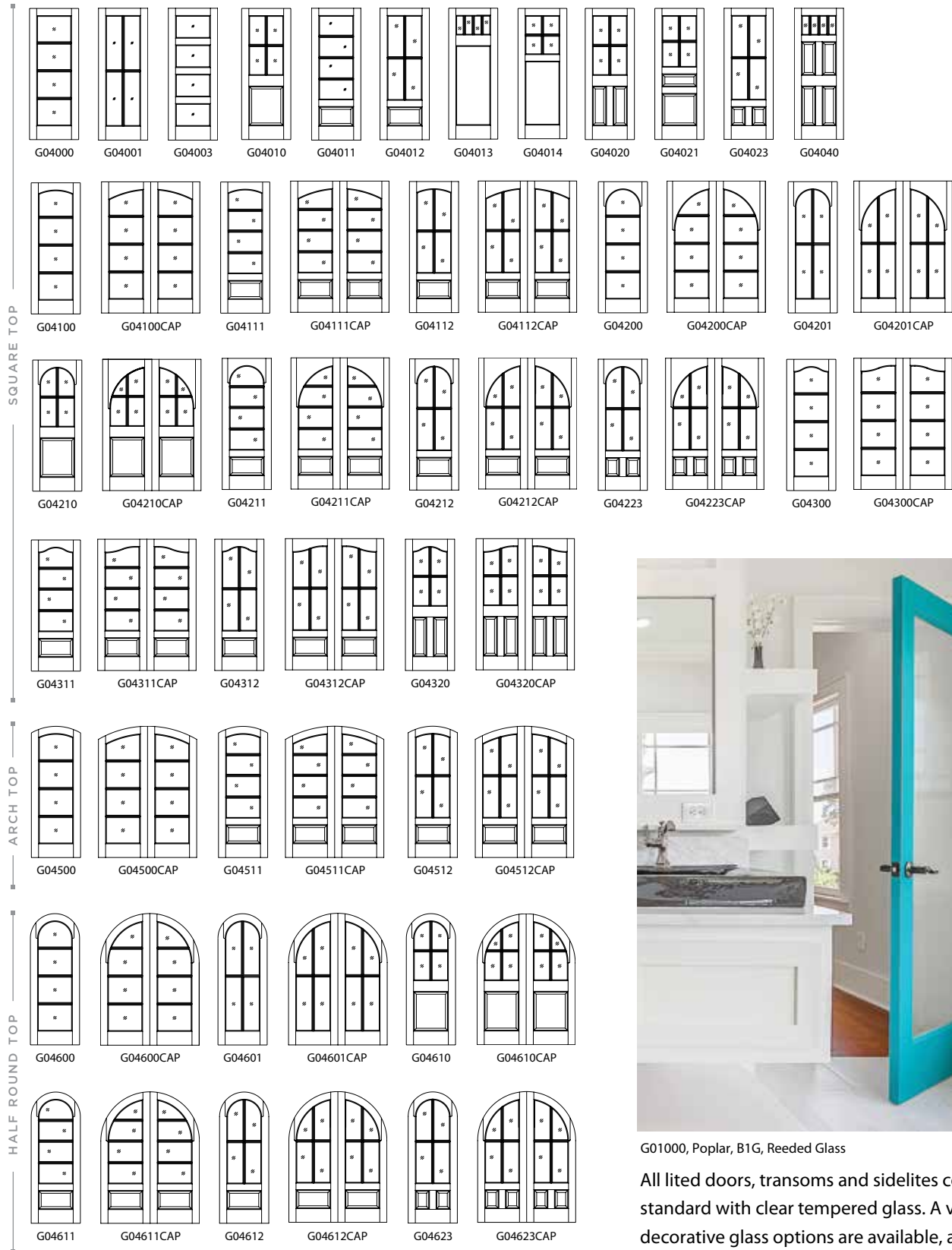

G01000, Poplar, B1G, Reeded Glass

All lited doors, transoms and sidelites come standard with clear tempered glass. A variety of decorative glass options are available, allowing you to create your own unique look. See pages 54-55 to view the entire glass collection.

REFERENCE GUIDE - LITED DOORS

5-LITE

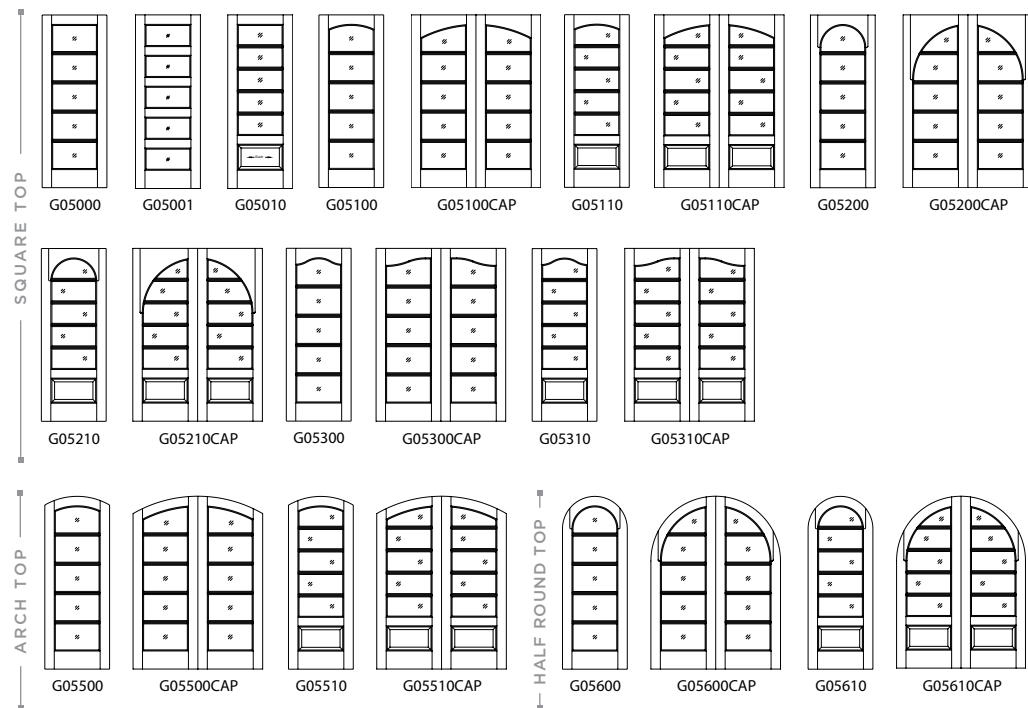

6-LITE

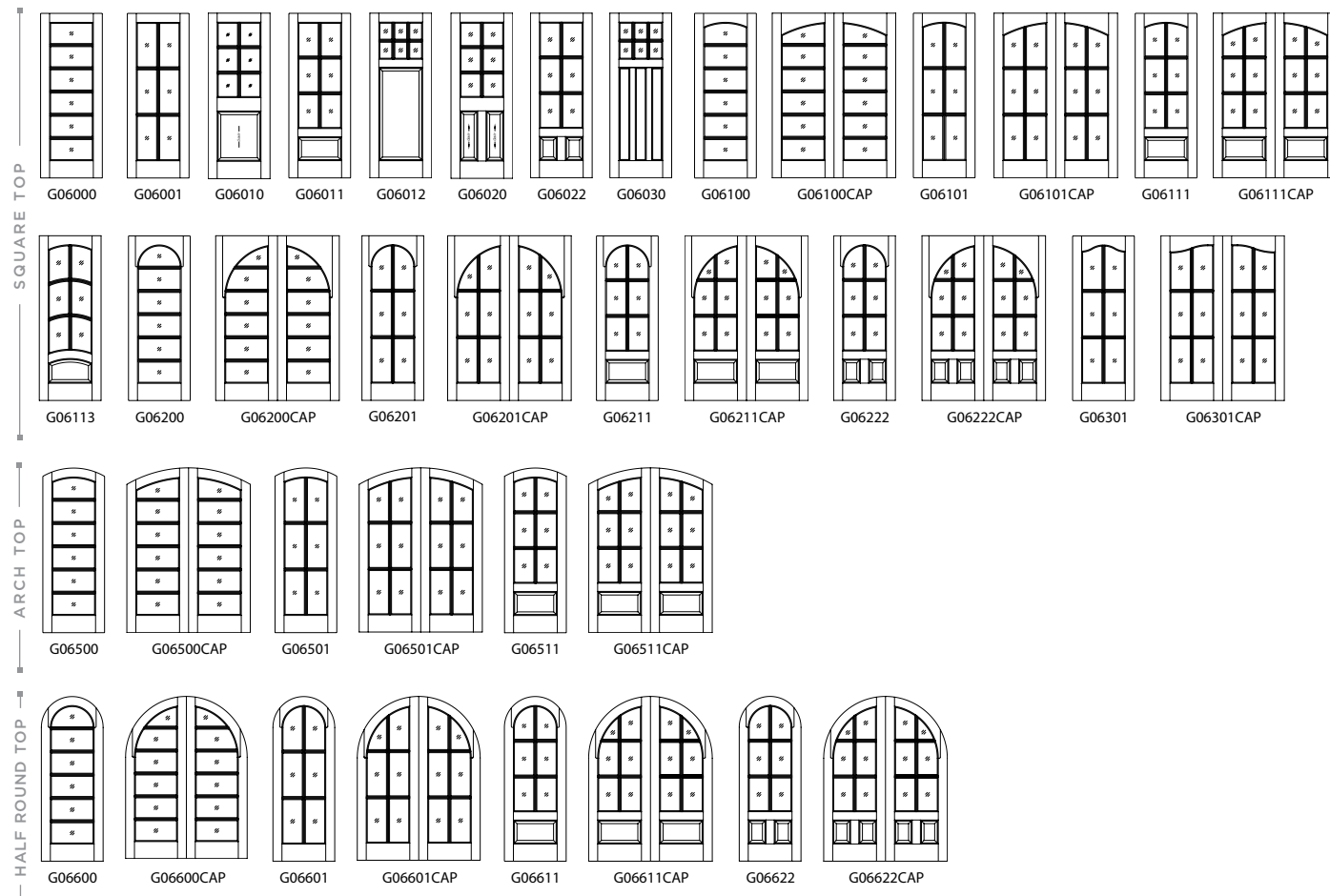

REFERENCE GUIDE - LITED DOORS

8-LITE

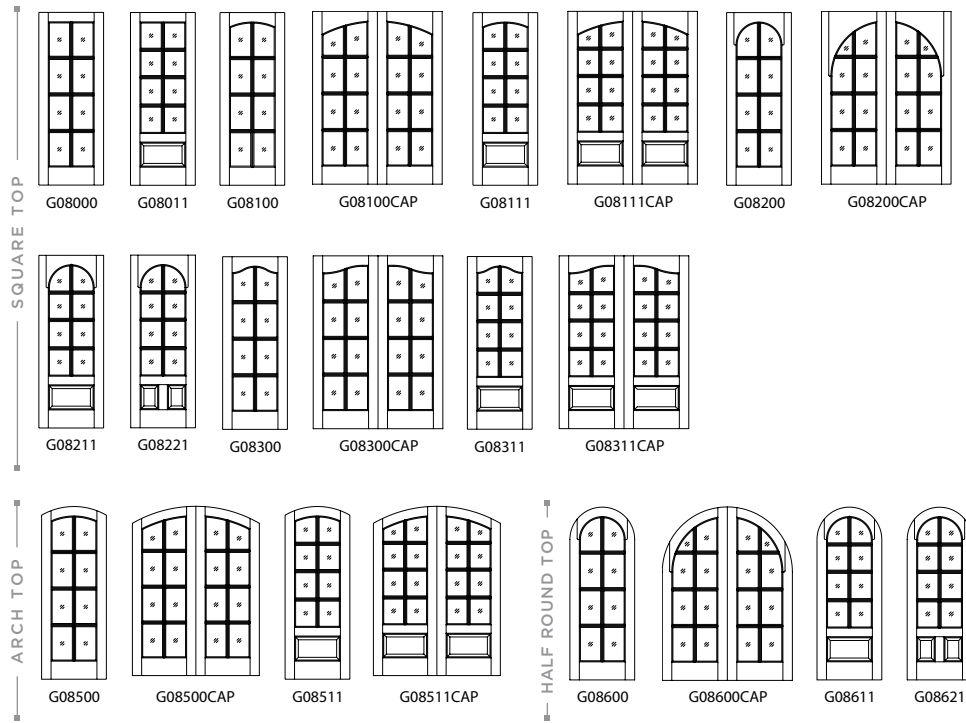

9-LITE

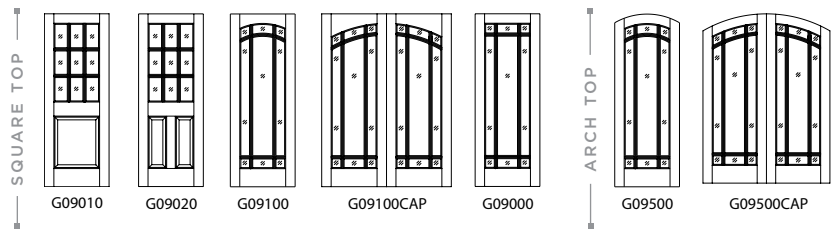

10-LITE

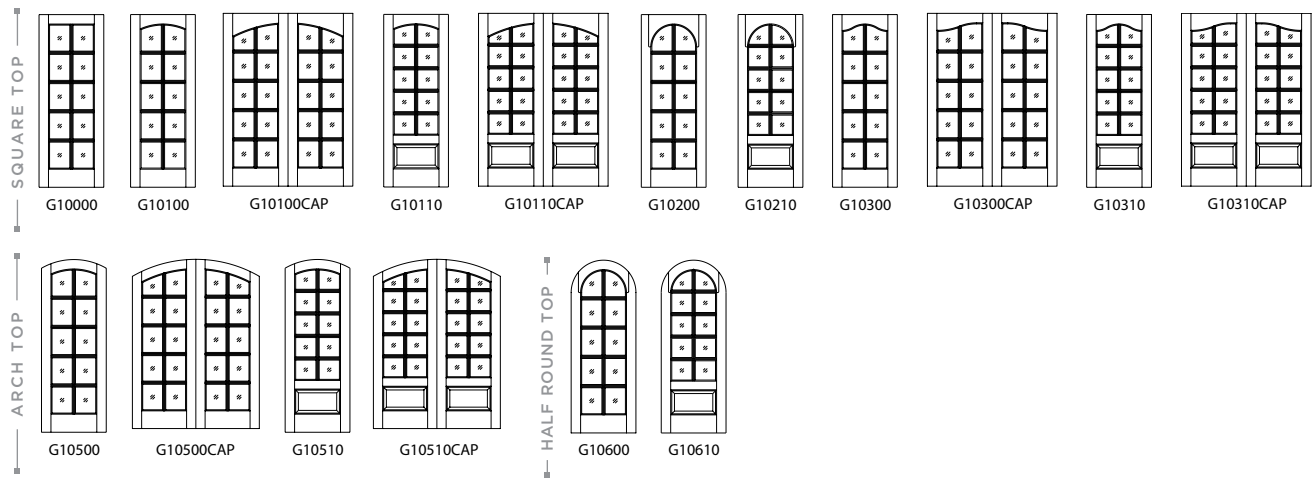

REFERENCE GUIDE - LITED DOORS

12-LITE

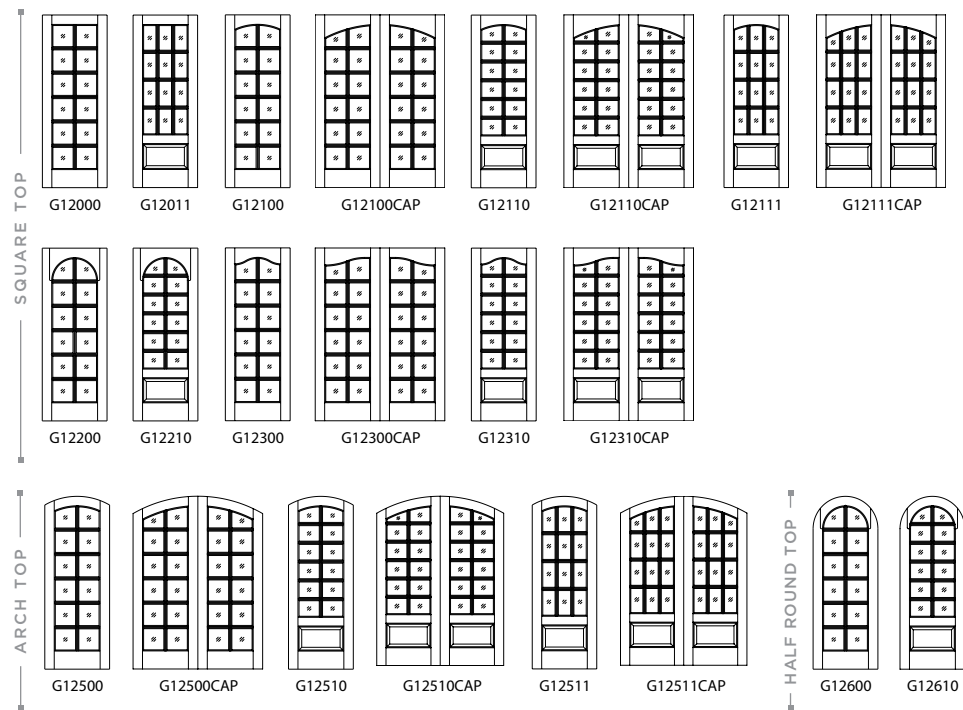

15-LITE

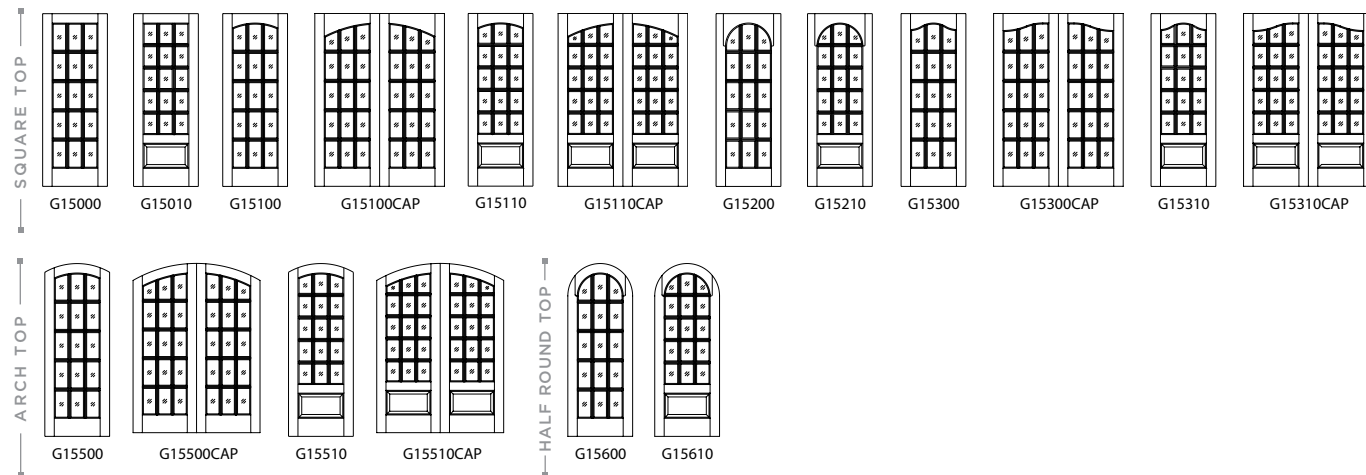

18-LITE

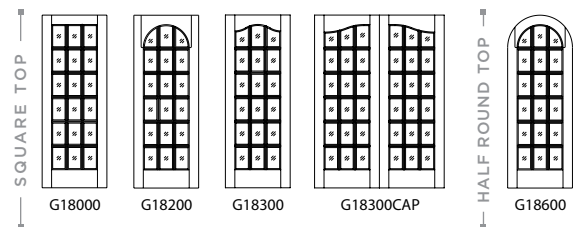

TRANSOM SASHES



T01000

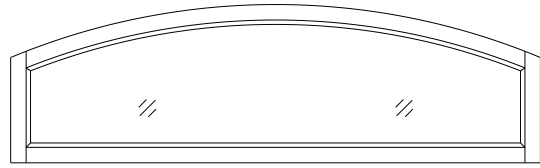

T01500

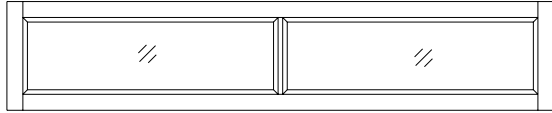

T02000

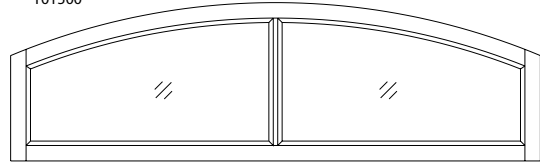

T02500

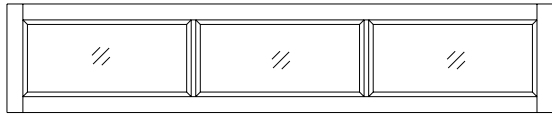

T03000

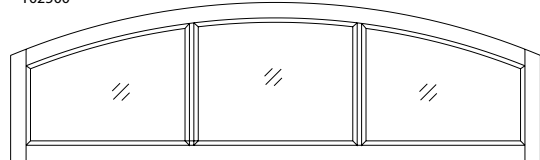

T03500

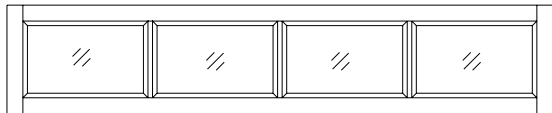

T04000

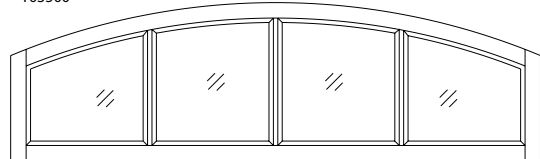

T04500

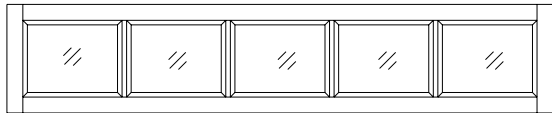

T05000

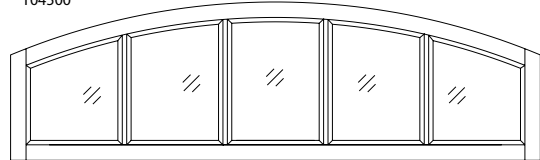

T05500

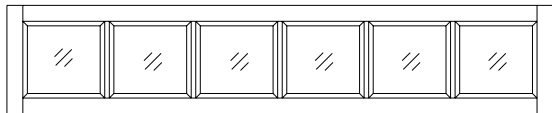

T06000

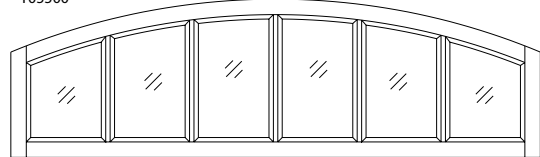

T06500

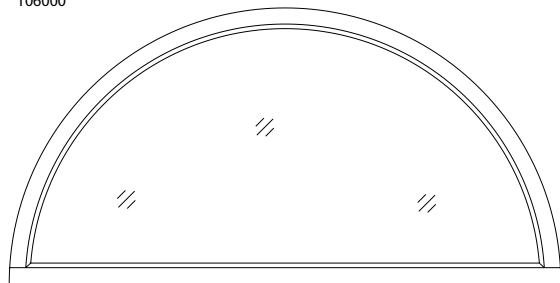

T01600

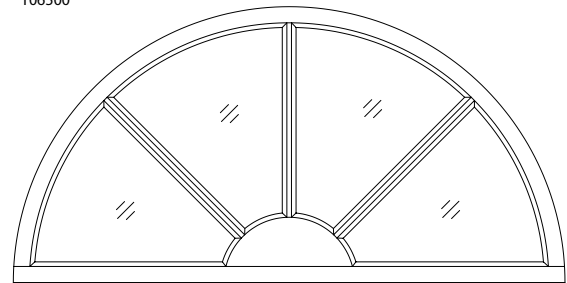

T04600

Drawings shown above feature Transom Sash construction. One lite transoms may also be ordered as Direct Set Transoms (shown bottom right). Please specify when ordering.

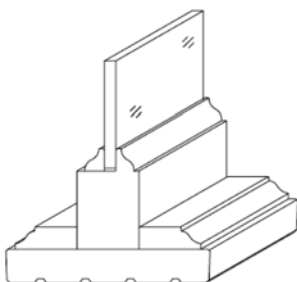

Transom Sash

Constructed using the same methods as our standard stile and rail, true divided lite doors.

The standard face rail width on a transom sash is 1 3/4".

When ordering a transom sash, please provide us with the dimension of the sash itself, not including the jamb.

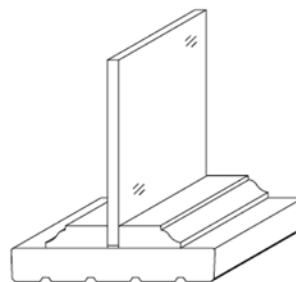

Direct Set Transom

Direct Set Transoms are constructed by "double stopping" the glass directly on to the jamb. *This option is only available with one lite transom designs.*

When ordering direct set transoms, it is important to specify whether dimensions given are "inside to inside" or "outside to outside" of the frame.

SIDELITES

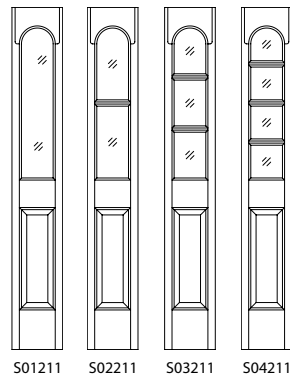
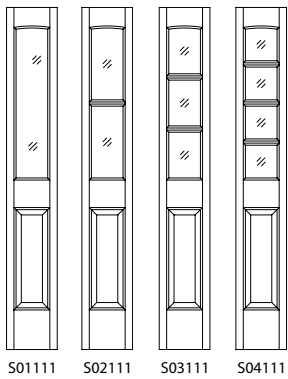
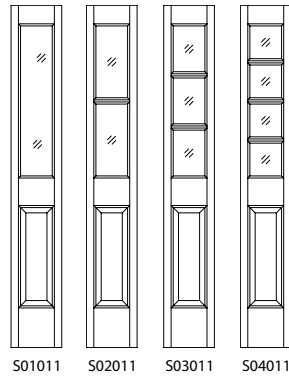
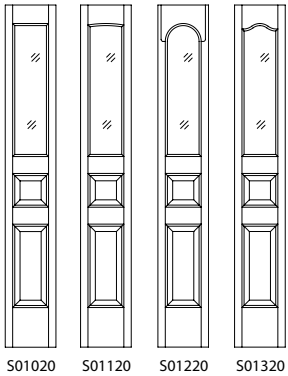
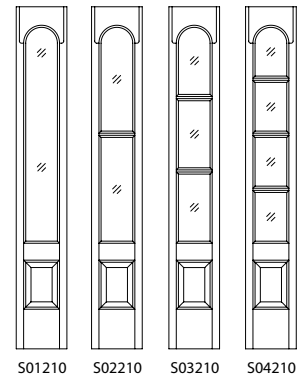
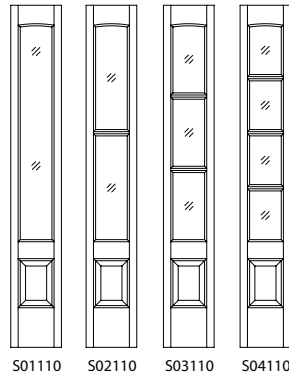
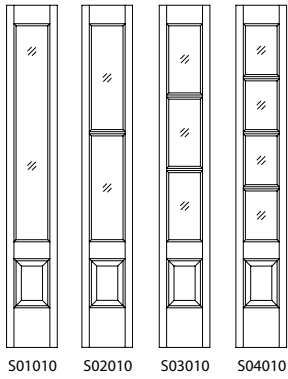
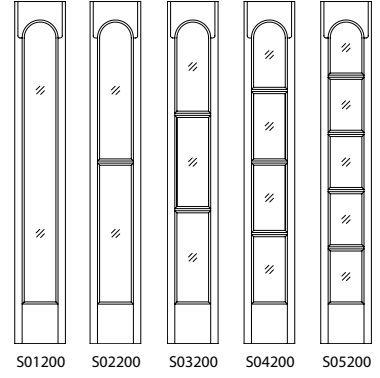
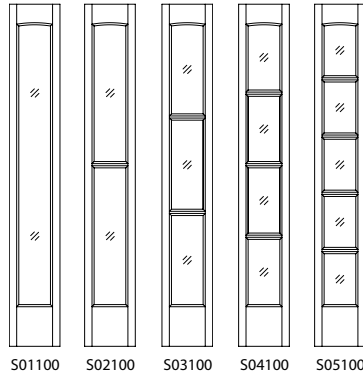
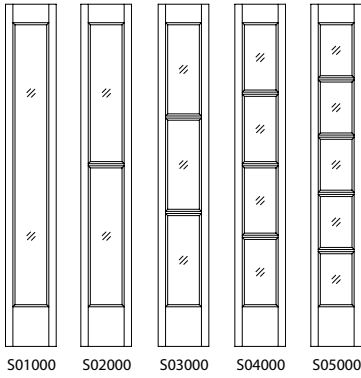

KW4000, E21-241, S01011 Sidelite, Aquatex glass, Poplar



INTERIOR GLASS OPTIONS

1-3/8" RAIL WITH 1/4" TEMPERED GLASS

Images are shown at 31% of size.

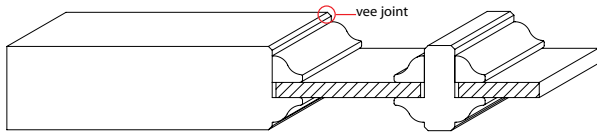

A1G

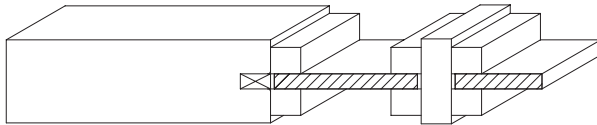

D1G

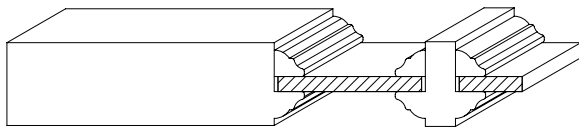

F1G

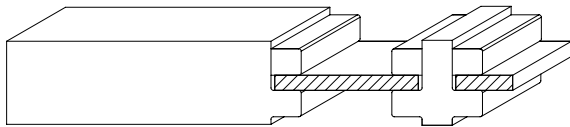

H1G

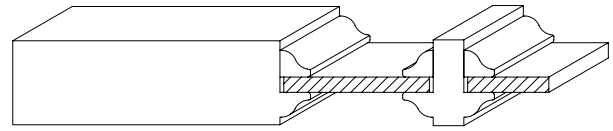

B1G

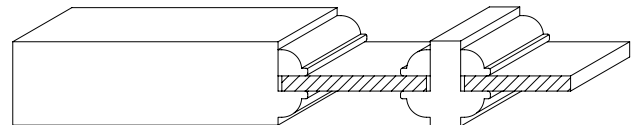

E1G

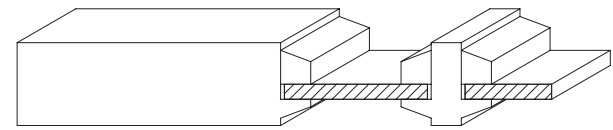

G1G

1-3/4" RAIL WITH 1/4" TEMPERED GLASS

Images are shown at 31% of size.

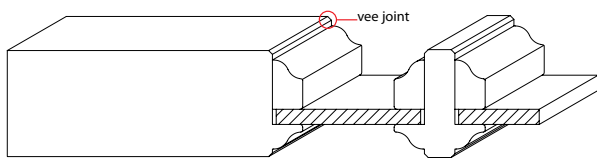

A2G

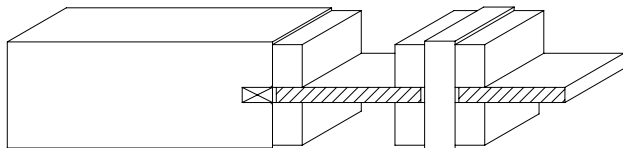

D2G

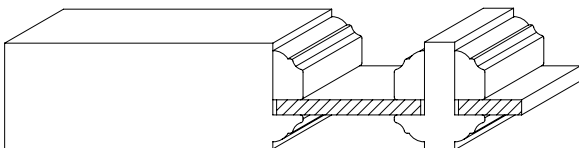

F2G

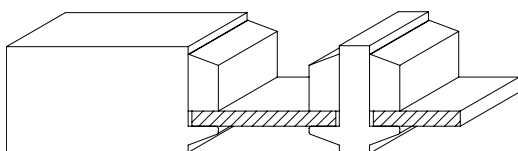

G2G

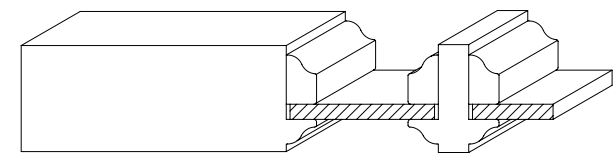

B2G

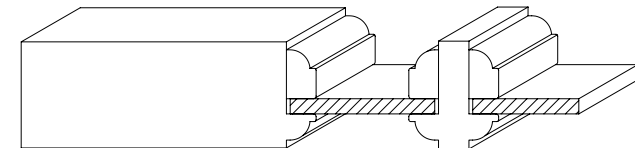

E2G

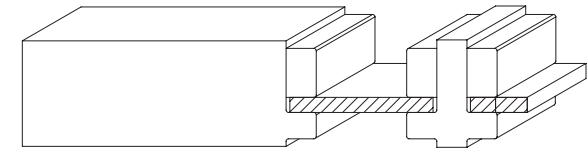

H2G

INTERIOR GLASS OPTIONS

2-1/4" RAIL WITH 1/4" TEMPERED GLASS

Images are shown at 35% of size.

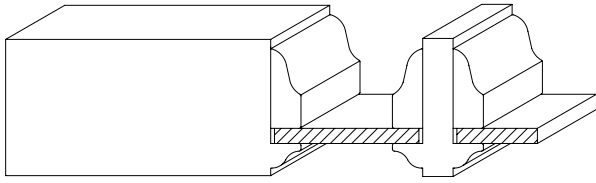

B5G

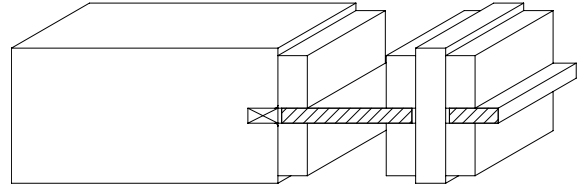

D5G

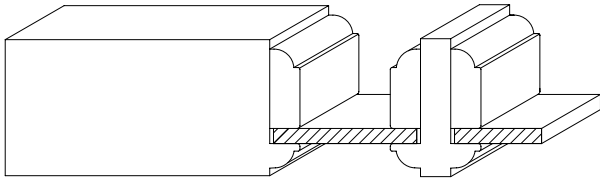

E5G

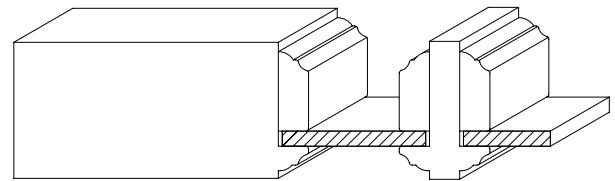

F5G

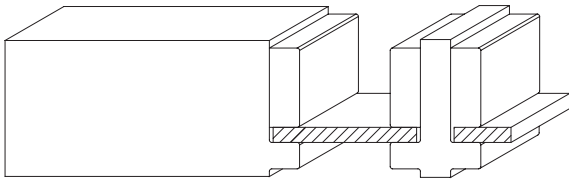

H5G

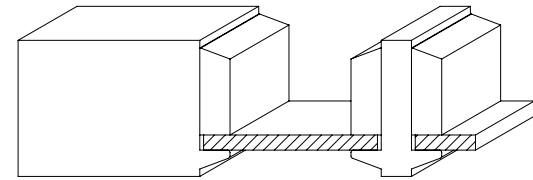

G5G



EXTERIOR GLASS OPTIONS

1-3/4" RAIL WITH 5/8" TEMPERED GLASS

Images are shown at 31% of size.

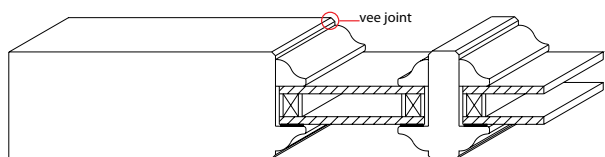

A2J

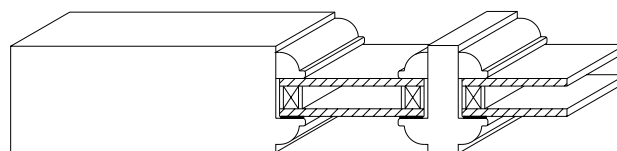

E2J

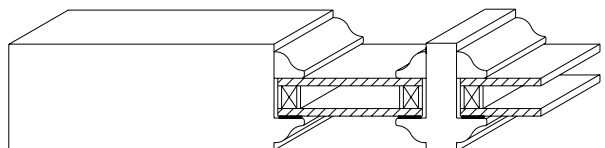

B2J

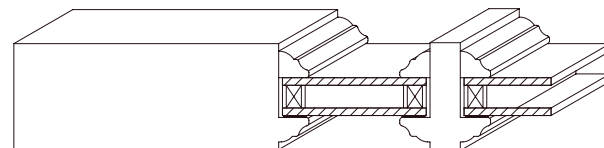

F2J

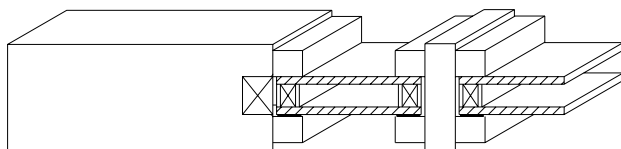

D2J

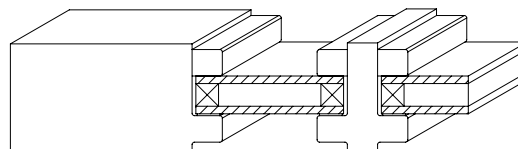

H2J

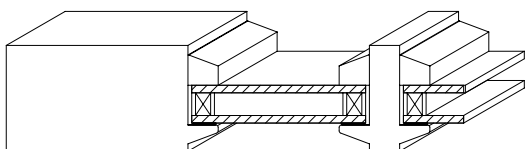

G2J (not available with door styles that contain panels)

2-1/4" RAIL WITH 3/4" TEMPERED GLASS

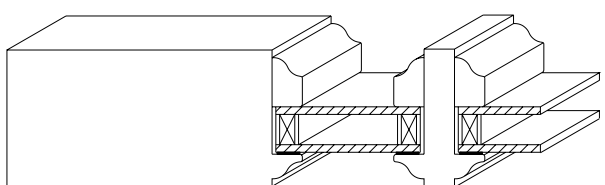

B5K

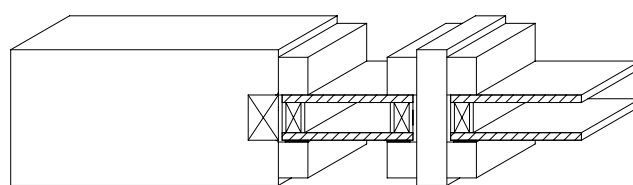

D5K

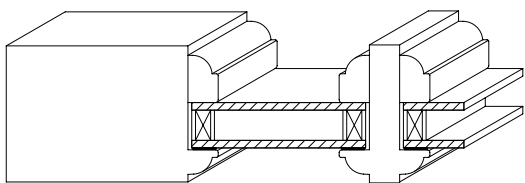

E5K

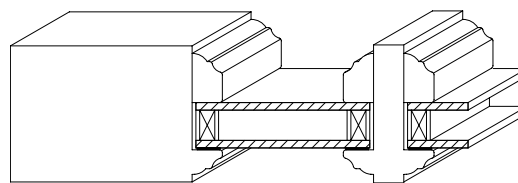

F5K

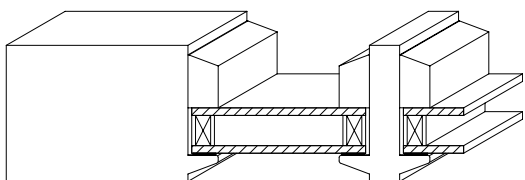

G5K

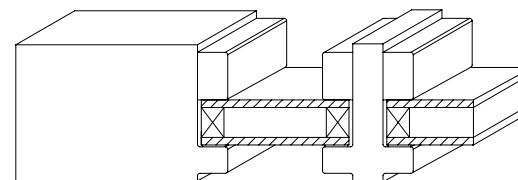

H5K



CUSTOM GLASS OPTIONS

Koetter Woodworking interior glass doors, transoms and sidelites come standard with clear tempered glass, or they may be ordered with any of these decorative glass options. All designs are available in insulated glass for exterior applications.



Aquatex



Autumn



Beveled



Bubbles



Cotswold

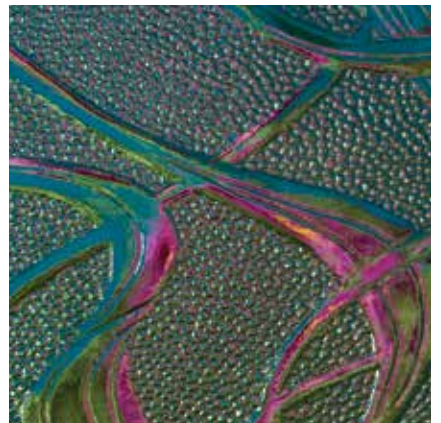

Everglade



Flemish



Glue Chip

CUSTOM GLASS OPTIONS



Opal (*Frosted*)



Master Linge

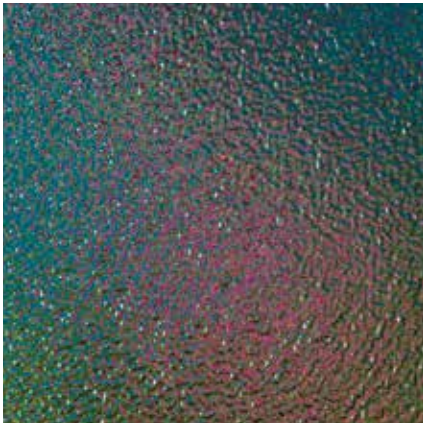

Pattern 62

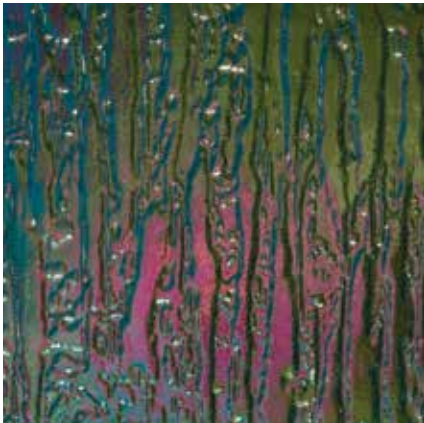

Rain

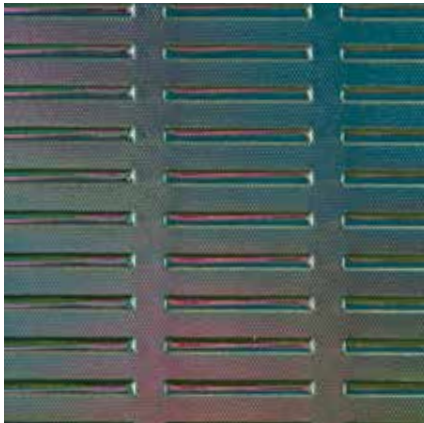

Master Ray

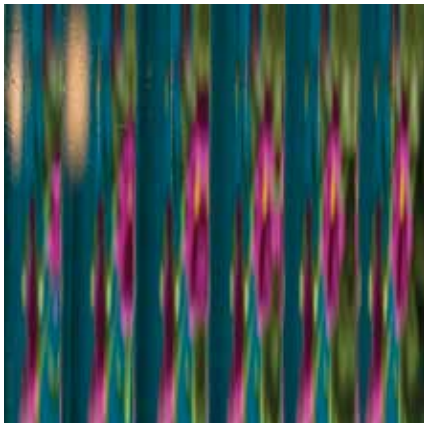

Reeded



Warick

HARDWARE

RESIDENTIAL HINGES 5/8" RADIUS CORNER



Antique Brass Finish



Antique Nickel Finish



Oil Rubbed Bronze Finish



Primed Finish



Flat Black



Satin Nickel Finish



Satin Brass Finish



Satin Chrome Finish



Bright Brass Finish



Bright Chrome Finish

Any hinge finish shown in our radius corner, residential offering (above) may be specified at no additional up-charge. In addition, we offer a wide selection of square corner, ball bearing and/or architectural hinges for an additional charge.

Please reference the Door & Jamb price book for all available options, along with pricing.

- = Square Corner Options Available
- = Radius Corner Ball Bearing Options Available
- ◆ = Square Corner Ball Bearing Options Available
- ▲ = Architectural Grade Options Available

Finish colors shown may vary due to the translation and reproduction limitations of photography.

STANDARD FLUSH BOLTS FOR 6'8" - 7'0" TALL DOORS



Satin Nickel HDW FB-US15 Antique Nickel HDW FB-US15A Oil Rubbed Bronze HDW FB-US10B (used with flat black hinges) Bright Chrome HDW FB-US26 Bright Brass HDW FB-US3 Antique Brass HDW FB-US5 Satin Chrome HDW FB-US26D

EXTENDED FLUSH BOLTS INCLUDES EXTENDED ROD FOR DOORS TALLER THAN 7'0" (SHOWN)



Satin Chrome HDW ELFB-US26D Flat Black HDW ELFB-US19 (used with oil rubbed bronze hinges) Satin Nickel HDW ELFB-US15 Bright Brass HDW ELFB-US3

MAGNETIC CATCH



HDW MAG CATCH
Concealed Magnetic Door Catch
Stainless Steel Finish

BALL CATCHES STANDARD BRIGHT BRASS ROLLER BALL SUPPLIED WITH EACH AS SHOWN



Bright Brass HDW BC-US3 Bright Chrome HDW BC-US26 Antique Nickel HDW BC-US15A Oil Rubbed Bronze HDW BC-US10B Satin Nickel HDW BC-US15 Satin Chrome HDW BC-US26D Antique Brass HDW BC-US5

Finish colors shown may vary due to the translation and reproduction limitations of photography.

HARDWARE

SILLS, EXTENDERS & WEATHERSTRIP



Bronze/Oak Adjustable Sill - In Swing

BRO A28036 - 5-5/8" w x 36" l
BRO A28073 - 5-5/8" w x 73" l

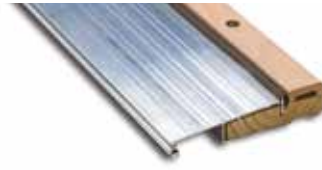

Aluminum/Oak Adjustable Sill - In Swing

ALU A28036 - 5-5/8" w x 36" l
ALU A28073 - 5-5/8" w x 73" l



Bronze/Oak Adjustable Sill - Out Swing

BRO A11436 - 5-5/8" w x 36" l
BRO A11473 - 5-5/8" w x 73" l

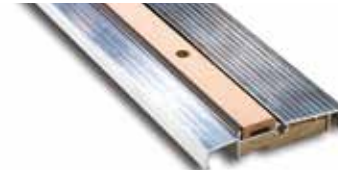

Aluminum/Oak Adjustable Sill - Out Swing

ALU A11436 - 5-5/8" w x 36" l
ALU A11473 - 5-5/8" w x 73" l



Bronze Sill Extension - 3"

BRO A112E36 - 3" w x 36" l
BRO A112E73 - 3" w x 73" l

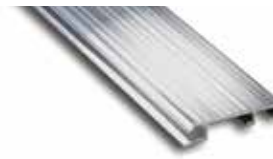

Aluminum Sill Extension - 3"

ALU A112E36 - 3" w x 36" l
ALU A112E73 - 3" w x 73" l



Bronze Sill Extension - 2"

BRO A112C36 - 2" w x 36" l
BRO A112C73 - 2" w x 73" l

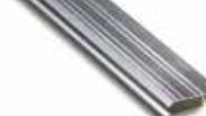

Aluminum Sill Extension - 2"

ALU A112C36 - 36" length
ALU A112C73 - 73" length



Bronze ADA Compliant Sill

BRO ADA36 - 36" length
BRO ADA74 - 74" length



Aluminum ADA Compliant Sill

ALU ADA36 - 36" length
ALU ADA74 - 74" length



Door Sweep for 2 1/4" Doors- Chocolate

CHO 48-DS214 - 48" length



Door Sweep for 1 3/4" Doors- Chocolate

CHO 36-DS - 36" length
CHO 48-DS - 48" length



Foam Weatherstrip - White

WHI 96-WS - 96" length



Foam Weatherstrip - Chocolate

CHO 36-WS - 36" length
CHO 81-WS - 81" length
CHO 96-WS - 96" length
CHO RL-WS - Random Length

Finish colors shown may vary due to the translation and reproduction limitations of photography.

POCKET DOORS

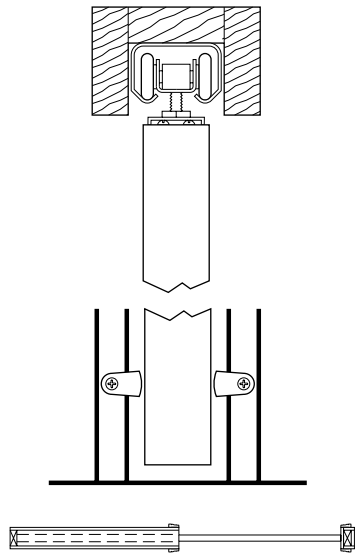

BY-PASS DOORS

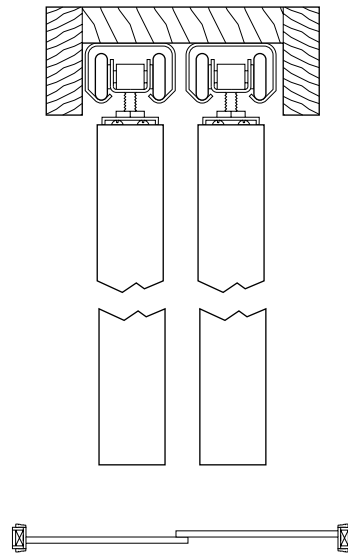

BI-FOLD DOORS

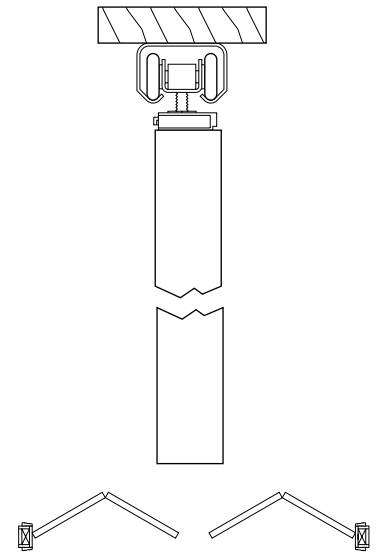

ITEM NUMBER	SIZE	DOOR THICKNESS
Pocket HDW 3068 Pocket HDW 3080 Pocket	2' to 3' wide up to 6' 8" high 2' to 3' wide up to 8' 0" high	1-3/8" to 1-3/4" 1-3/8" to 1-3/4"
By-Pass HDW 5 By-Pass HDW 6 By-Pass HDW 8 By-Pass	5' / two 2' 6" 6' / two 3' 0" 8' / two 4' 0"	1-3/8" to 1-3/4" 1-3/8" to 1-3/4" 1-3/8" to 1-3/4"
Bi-Fold HDW 3 Bi-Fold HDW 4 Bi-Fold HDW 5 Bi-Fold HDW 6 Bi-Fold HDW 8 Bi-Fold	2 door - 3' opening 4 door - 4' opening 4 door - 5' opening 4 door - 6' opening 4 door - 8' opening	1-1/8" to 1-3/4" 1-1/8" to 1-3/4" 1-1/8" to 1-3/4" 1-1/8" to 1-3/4" 1-1/8" to 1-3/4"

DOOR SWINGS

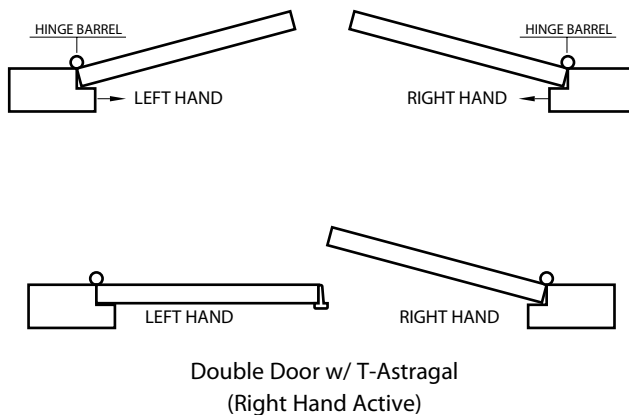

STANDARD BORE

2-1/8" Bore with 2-3/8" Backset
1" Plunger Hole

Standard bore location 35 15/16" from bottom of door.
Certain optional bores available upon request.

ABBREVIATIONS

S.B. - Standard Bore
N.B. - No Bore
R.H. - Right Hand
L.H. - Left Hand
DBL - Double Hung

JAMBS & ACCESSORIES

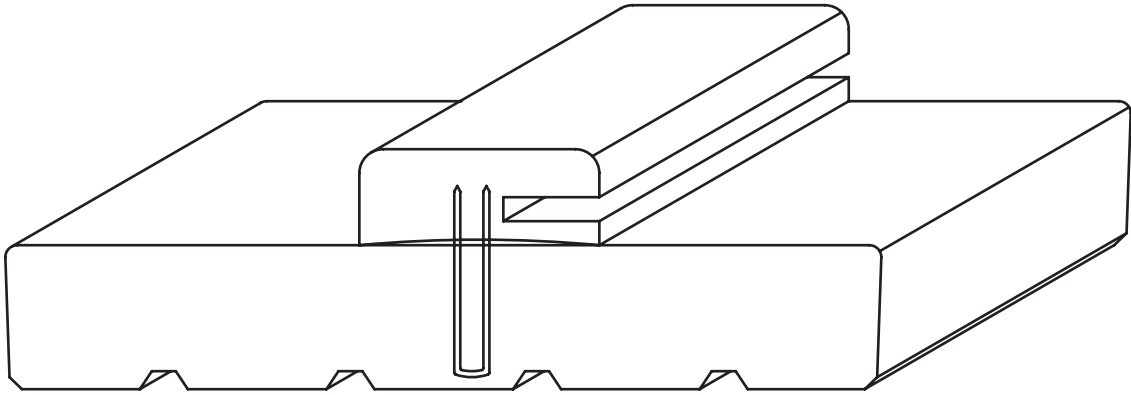

Applied Stop Jamb
Kerfed for weatherstrip

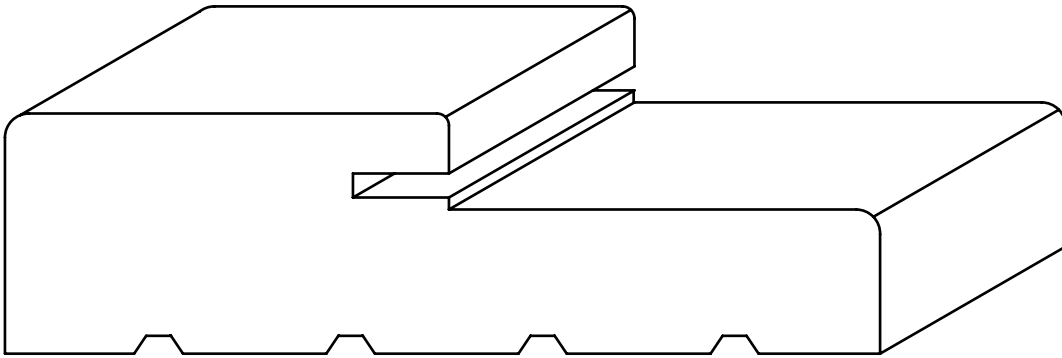

Single Rabbeted Exterior Jamb
Kerfed for weatherstrip

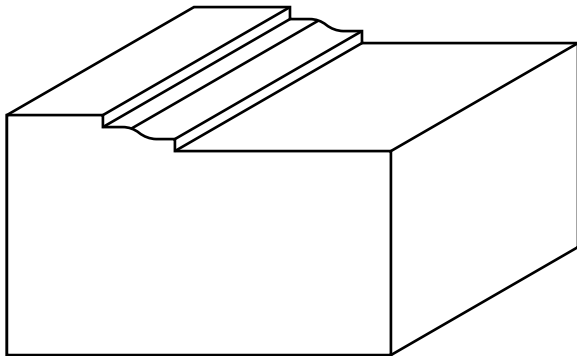

4064-BR 1 1/4" x 2"
Brick Mould

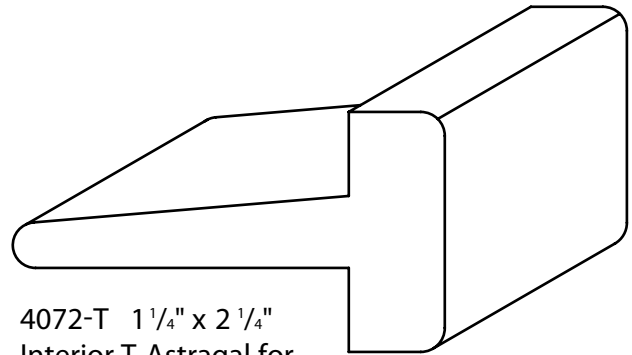

4072-T 1 1/4" x 2 1/4"
Interior T-Astragal for
1 3/8" or 1 3/4" door

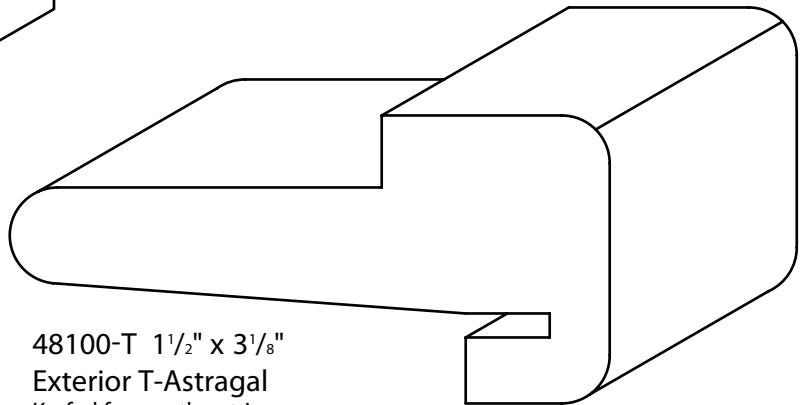

48100-T 1 1/2" x 3 1/8"
Exterior T-Astragal
Kerfed for weatherstrip

JAMBS & ACCESSORIES

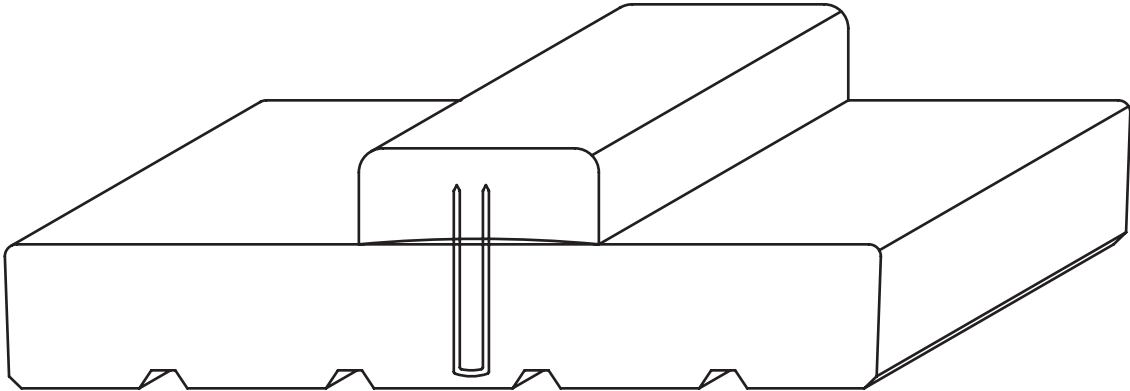

Applied Stop Jamb

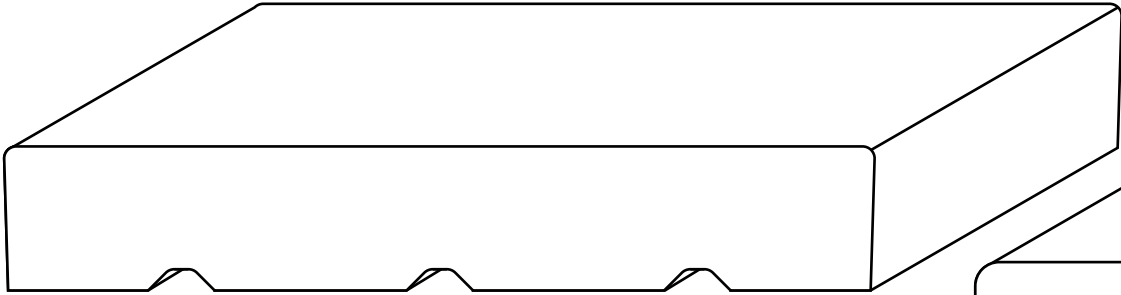

Flat Jamb

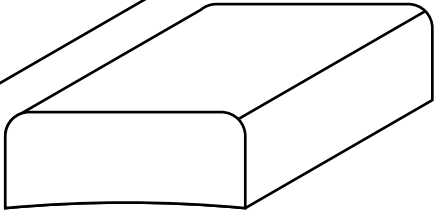

1640-Stop $\frac{1}{2}$ " x $1\frac{1}{4}$ "

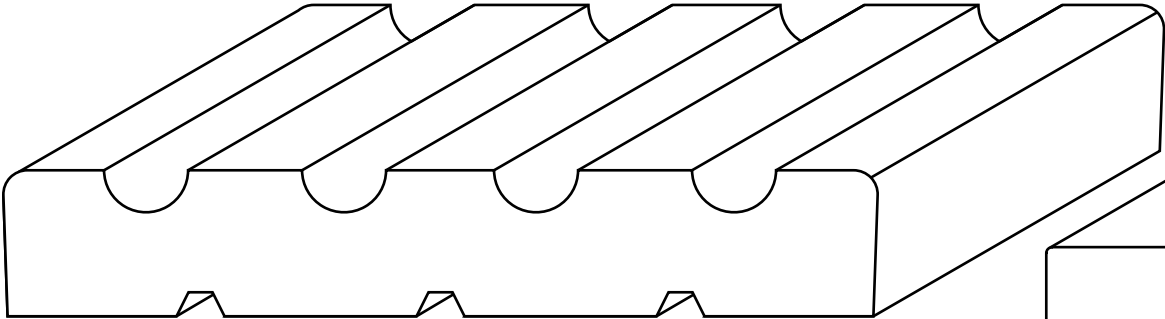

Fluted Jamb

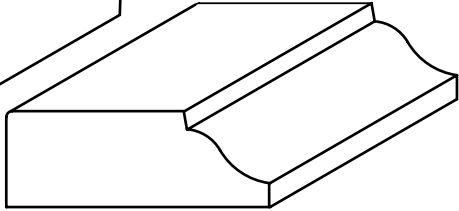

1644-KW-Stop $\frac{1}{2}$ " x $1\frac{3}{8}$ "

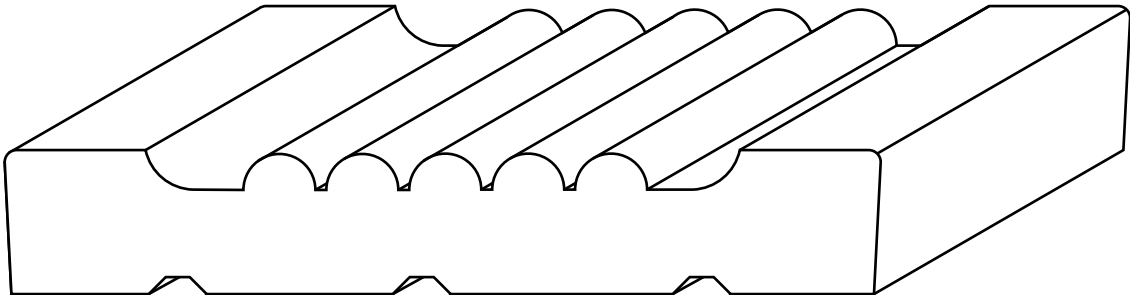

Reeded Jamb

AVAILABLE SPECIES & CONSTRUCTION FEATURES

Our furniture quality doors are hand-crafted from some of the finest woods available. Additional species are available upon request.



Alder
(stiles may be edge glued)



Knotty Alder
(stiles may be edge glued)



Cherry



Vertical Grain Fir



Hickory
(limited availability based on door style/size)



KW Mahogany



Hard Maple



Red Oak



Red Oak
(rift and quartered)



White Oak



White Oak
(rift and quartered)



Walnut
(stiles may be edge glued)



White Pine



Knotty White Pine



Cypress



Poplar

Photography does not represent all of the natural variation in grain and color that will occur in the production of a complete door package.

QUALITY CONSTRUCTION FEATURES

Profiles are precision machined with diamond and carbide tooling, resulting in well-defined detailing.

Solid wood panel construction provides crisp, detailed edges unlike veneer wrapped panels.

5/8" x 4" solid wood dowel is used at every stile and rail joint providing added strength and stability.

Free floating panels with flexible rubber spacers allow the panels to stay centered during normal expansion and contraction.

Doors feature solid, hardwood stave core stiles* with a substantial 1/8" lumber face, solid wood rails and panels, providing exceptional strength and stability.

* All knotty species as well as fire rated doors are manufactured with face laminated stiles.

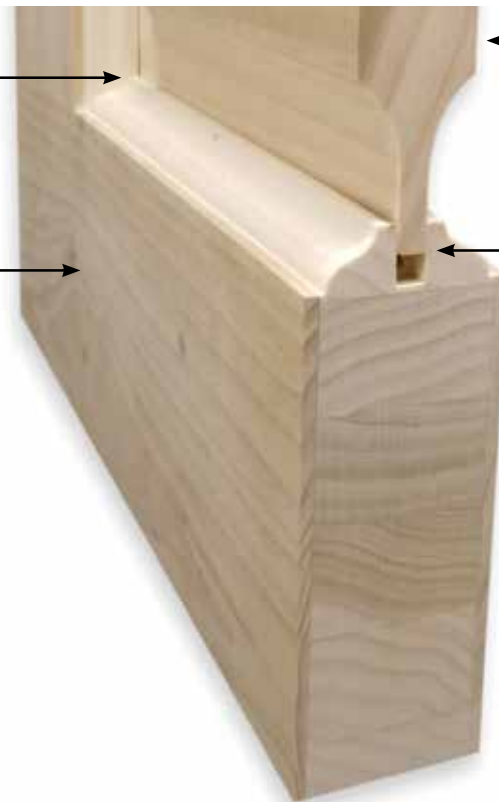



- All doors manufactured by Koetter Woodworking, Inc. are individually shrink-wrapped, with some exceptions, for protection against moisture and dirt. Doors can be shipped and installed with the shrink-wrap still intact until they are ready for finishing.
- Job-lot quantities of pre-hung doors up to 8'0" tall are shipped vertically on steel skids. These skids can be forklifted off at your facility where you can then ship them directly to your job site. This reduces the chances of doors becoming damaged during shipment, as well as providing an easy method of loading and unloading large quantities of doors. Any door units wider than 3'4" and all double hung units will be machined and pre-assembled but shipped knocked down.
- Pre-hung units over 8'0" tall are shipped on horizontal wood pallets.
- All steel skids remain the property of Koetter Woodworking Inc. and must be returned within 30 days.
- Koetter Woodworking can manufacture doors to meet almost any specification or design. If you don't see it in our catalog, just send us a picture and we will do our best to match it.
- **Detailed information on Koetter Woodworking's Limited Lifetime Warranty can be accessed on our web site at www.koetterwoodworking.com.**





Koetter Woodworking, Inc.
(812) 923-8875
800-411-8285 toll free fax
www.koetterwoodworking.com